

ANCIENT LAMPS FROM BEREZAN:
THE HERMITAGE COLLECTION

PIERRE DUPONT
with the contribution of
SERGEI SOLOVYOV

PONTICA LIII
SUPPLEMENTUM VII



MUSÉE D'HISTOIRE NATIONALE ET D'ARCHÉOLOGIE
CONSTANȚA
2020

PONTICA LIII
SUPPLEMENTUM VII

PIERRE DUPONT
(ArAr Lab, Maison de l'Orient, Lyon)

With the contribution of

SERGEI SOLOVYOV
(State Hermitage Museum, St. Peterburg)

**ANCIENT LAMPS FROM
BEREZAN:
THE HERMITAGE
COLLECTION**

CONSTANȚA
2020

Informatique éditoriale
MARIA BOLOCAN

Couverture
ADA-ADINA MARCU

Rédaction : Musée d'Histoire Nationale et d'Archéologie, 12 Place
d'Ovide, 900745, Constantza, Roumanie, Tél./Fax 0040-241-618763 ;
e-mail : revista.pontica@gmail.com.

PONTICA en ligne : www.revistapontica.wordpress.com

ISSN 1013-4247
ISSN (online/en ligne) 2247 – 9341
ISBN 973-7951-29-8

**SUMAR
SOMMAIRE
CONTENTS**

FOREWORD.....	5
ARCHAIC EAST GREEK LAMPS IN THE PONTIC AREA.....	6
POST-ARCHAIC BEREZAN LAMPS: PRELIMINARY LAB APPROACH.....	18
CANDLESTICKS PRECURSORS ?.....	19
ARCHAIC EAST GREEK LAMPS: PRELIMINARY LAB APPROACH.....	21
CATALOGUE.....	22
BIBLIOGRAPHY.....	59
CROSS-REFERENCES TO THE ILLUSTRATIONS.....	64
FIGURES.....	71
PLATES.....	103

FOREWORD

It is on the occasion of a series of study stays of the gray wares from Berezan in the Hermitage collection, together with my Romanian colleague Vasilica Lungu, that I had my attention attracted by the associated collection of lamps. I am indebted to Sergey Solovyov, keeper of the Berezan collection, for having provided me with both available photos and drawings of most of them, as well as basic pieces of information about the individual excavation contexts of these items¹. Yet, considering the first rate documentary importance of this lychnological assemblage, it seemed to me that it was worth publishing it, despite the inadequacies of the too weak chronological landmarks provided by the attached field notices either for dating or statistical distribution². Furthermore, several inventoried items have not been found and had to be removed, whereas other uninventoried ones (referred to as « *non vidi* ») were attested in photos only.

Beside a crushing majority of Archaic Eastern Greek types, side by side with some assumed later ones of less clearly identified Greek origin, the collection was supplemented by a single handmade one of native type as well as by two somewhat anachronic Roman intrusions.

¹ Incidentally, the same remark applies in the case of the counterpart collection of lamps from Berezan in the Historical Museum, Moscow published by ZHURAVLEV & KHRSHANOVSKI 2003.

² The Hermitage collection only represents the share of finds made by the archaeological expedition of the museum on the island of Berezan, whereas the remaining ones are scattered between Kiev and Odessa museums.

ARCHAIC EAST GREEK LAMPS IN THE PONTIC AREA

As in the case of pottery vessels, the East Greek settlements of the Northern Black Sea provide a representative overview of the main types of lamps distributed by their motherland cities of Ionia all along the archaic period. Unfortunately, the identification of the significant exporting centres appears somewhat uneasy, because the motherland finds still remain unequally studied, except perhaps those of the Samian Heraion. Typologically, these Greek lamps from the Black Sea area constitute a rather diversified whole, most predominantly of Eastern Greek origin, within which some well-defined models stand out, intentionally mass produced for the export markets, on which they were often supplemented by some colonial imitations, such as those evidenced in Berezan itself³, of a shape recalling South-Ionian originals⁴ and already attested in between in Apollonia⁵.

With a few exceptions, all the shapes in question are wheelmade. They fall into three main categories: models with more or less carinated body, mostly funneled ones (« Stocklampen »); others with rounded body and more or less incurved rim (« Rundschulterlampen »); and other ones with folded rim (« Knickrandlampen »).

Several areas of manufacture seem involved, obviously shared out between South Ionia, North Ionia and Aeolis. Most of these lamps seem to have been produced by the same East Greek workshops as vases; however, the fact that the consignments of pots were mainly originating from the northern part of Eastern Greece doesn't appear to be conclusive enough, because standard models exported overseas might well have been manufactured by specialized producers located anywhere else, as in the case of the widespread series of fine Ionian cups.

Compared with the imports from Asia Minor, those originating from mainland Greece (Athens, Corinth) appear to be quite in a minority until the end of the archaic period.

Concurrently, colonial workshops started manufacturing lamps themselves: very often, these are restricted to simple models with grey clay and black slip, presumably made in the same workshops as the common grey ware, but some others fired in oxydizing atmosphere, with light or even whitish clay, with or without any painted decoration.

Lastly, on the Hellenic settlements of the Euxine, a number of small-sized coarse handmade open lamps are attested as well. They are related to the native handmade pottery, though not necessarily of native manufacture.

Concerning more especially the Northern-Pontic area, the fuel used for lighting devices might well not have been restricted at all to olive oil. On the one hand, the identification of obvious precursors of candlesticks among the archaic pottery finds from Berezan suggests that solid organic fuels such as tallow of

³ See KRUTILOV *et al.* 2017, p. 34 fig. 3.

⁴ e.g. among the finds from Assesos see KALAITZOGLOU 2008, Taf. 158 Form 2.

⁵ See DAMYANOV (2018), p. 96 fig. 4, upper row.

animal origin, locally produced⁶ - first of all by the natives, either nomadic or settled, but also by the Greek colonists -, appear to have been used for lighting devices by the Greek colonists, far away from their olive oil producing homeland. Not to mention the highly valuable beeswax⁷, a widespread by-product of the bitter honey from Pontus⁸ which might have been also used for the making of more advanced candles, fitted with flax wicks, as our modern ones⁹. On the other hand, both the Crimea and the Taman peninsula contain superficial naphtha seepages, overflowing out in numerous places, a kind of liquid fuel already in use by the Greeks for various purposes as mentioned by ancient sources¹⁰. If the use of liquid bitumen is mainly documented for the Late Roman¹¹ and Byzantine¹² periods, a recent archaeological discovery made on the Taman peninsula, viz. one Late Archaic transport amphora of Zeest's « Protothasian » type might well suggest a much earlier practice of it¹³. The fact is that all kinds of fuels for lighting were available throughout the Northern Black Sea area: tallow, wax as well as naphtha.

In starting the study of the Hermitage collection of archaic lamps from Berezan, a short review of the main imported types and their local imitations, as well as some less attested others of particular interest, is needed.

Lamps of « Samian » type (Howland type 9)

They form a family of lamps with very characteristic features, the distribution area of which covers both the Mediterranean and the Black Sea.

⁶Available statistics on the percentages of animal bones from settlements of the Lower Dnepr-Bug basin have to be interpreted carefully to get an idea of the general distribution between cattle, sheep and goat, due to the disparity of cattle breeding patterns between Greek and Scythian settlements, either nomadic or sedentary : whereas at Olbia during the Classical period, sheep and goats were slightly more numerous than cattle, on the Scythian sedentary settlement of Kamenskoe Gorodishche (Lower Dnieper region), the livestock consisted in 40% horses, 40% cattle and less than 18% sheep (see BLAVATSKII 1953 , p. 100-102 ; ZHURAVLEV 1983 ; ZHURAVLEV *et al.* 1990). As for Berezan itself, due to its insularity, it obviously represents all along the Archaic period a special case with only ca. 1% horses, not more than 21% cattle vs. a sheep & goats ratio ranging from 40 to 65% (see KASPAROV 2012).

⁷ Dioscoris, *De mat.med.* II, 105; Polybius IV, 38; Pliny, *Nat.Hist.* XI, 59, XXI, 83; Strabo, XI, 2, 17 (Colchis). Not to mention Herodotus V, 10, according which all countries beyond Istros were ruled by bees.

⁸ So much so that one Southern Pontic tribe, the Sanni, was reported to use it for paying its tribute (Pliny VI, 14).

⁹ See LE NORMAND 1828 for a detailed account of their manufacture process.

¹⁰ Dioscoris, *De mat. med.*, I, 73, already reports the use of asphalt instead olive oil in their lamps by the inhabitants of Akragant / Agrigento in Sicily, whereas Poseidonius III, Fgt. 235, mentions that bitumen was also found in Rhodes, but that it needed to be fluxed by a greater mixture of olive oil to cure vermin-infected vines. The use of burning black naphtha / liquid asphalt in lamps instead of oil is also reported in Babylonia by Posidonius III, Fgt. 236 / Strabo, XVI, 1, 15.

¹¹ KOSTRIN 1971.

¹² KOSTRIN 1965.

¹³ We are indebted to Sergey Solovyov for this information of great importance.

Their particular frequency among the finds of the Samian Heraion¹⁴ led to attribute them a bit rashly to local workshops, while this panhellenic sanctuary has revealed quite a lot of cosmopolitan offerings. Previously, they were given the denomination of « Smyrnean lamps » by Howland (type 9) for the same debatable reasons¹⁵. Nevertheless, their homeland might well be Middle and South Ionia, to judge after their high concentration, in addition to the Samian Heraion, at the Ephesian Artemision¹⁶ and in Miletus¹⁷ and Assesos¹⁸. Besides, they are attested in the Dodecanese area¹⁹ and at Naucratis²⁰.

All of them are made of very micaceous clay and are characterized by a central slightly protruding funnel, squat carinated body, vertical or slightly offset rim, either grooved on top (until the turn of the 7th cent. BC) (**Pl. 1b, 2a**), or smooth (**Pl. 1a**), or flattened with slightly projecting fillet (**Pl. 2b**). Most of these lamps do not bear any painted decoration, but often show, on both sides of the nozzle, a couple of small, stamped circles, more rarely of L; only a few developed specimens have received a painted coating on the inside of the oil container.

In the Black Sea area, these lamps were, seemingly, sparsely distributed, except an important concentration in Berezan²¹. Specimens with grooved rim are attested only on the most ancient sites: first of all in Berezan²² and, less frequently, in Histria²³.

One of our samples from Histria as well another one from Miletus actually revealed a South-Ionian chemical pattern, but rather Milesian than Samian, whereas another one from Histria drew aside falling into a North-Ionian cluster (Clazomenae).

Thin-walled carinated lamps, with strongly protruding funnel or cone

Slightly bigger but lighter than the former, these lamps stand out by a narrow everted rim and a protruding slanting central funnel (**Pl. 1c, 2c**) or strongly emphasized cone (**Pl. 2d**), highly toping the level of the body.

In Eastern Greece, the funnelled variants found at the Samian Heraion are also considered as local products by the German excavators, but the attribution would well need confirmation. Rather closely related pieces with painted

¹⁴ KOPCKE 1968, p. 272-275 n° 68a-l, fig. 22-23, pl. 105; FURTWÄNGLER 1989, p. 115 I/33, fig. 22, pl. 24 (ca. 590-570), 122 II/11, fig. 23, pl. 26 (ca. 570-550), 125 III/5, fig. 25, pl. 28 (2nd/3rd quarter of 6th cent.).

¹⁵ HOWLAND 1958, p. 20-22, pl. 3, 31 (*Smyrna lamps; bridged nozzles*).

¹⁶ BAILEY 1975, p. 93-94, pl. 28-29 Q 146, Q 148.

¹⁷ SELESNOW 1997, p. 137, 140 fig. 25 (Kalabaktepe).

¹⁸ KALAITZOGLOU 2008, p. 289-291, pl. 158.

¹⁹ KINCH 1914, col. 159-160, pl. 27: 9b (Vroulia); JACOPI 1932-1933, p. 495, fig. 21 (Nisyros).

²⁰ BAILEY 1975, p. 94, pl. 28-29 Q 147.

²¹ Hermitage B. 64-219, B. 67-163, B. 69-244, B. 70-206, B. 71-253, B. 71-254, B. 73-265, B. 77-208, B. 77-210, B. 78-79, B. 82-75, B. 84-203, B. 85-74, B. 89-101.

²² Hermitage B. 64-219, B. 71-253, B. 71-254, B. 73-265, B. 77-208, B. 78-79, B. 84-203.

²³ Lambrino excavations 1927-42, unpublished.

decoration have been discovered at Bayrakli²⁴ and Gravisca²⁵. In the Black Sea area, only the painted variant is represented both in Histria²⁶ and Berezan²⁷.

Thick carinated lamps, with moderately protruding funnel or cone and projecting rim

The carinated body of these carinated lamps is surmounted by a wide projecting rim, sloping inwards and frequently surrounded by a fillet. The funneled variant (**Pl. 1e, 2e**) seems more frequent than the umbilic one (**Pl. 1f, 3a**).

These models have been widely distributed throughout the Mediterranean, from Samos²⁸ to Gravisca²⁹ via Tocra.³⁰ In the Black Sea, shapes either funneled or with central cone are well documented at Berezan³¹ and Histria³². In the case of Histria, chemical analyses have evidenced a Clazomenian fabric for two samples as well as one local imitation.

Sharply carinated lamps with broad flattened rim

Thinner-walled than the former, these lamps are of umbilic type. Their main feature lies in a sharp folding of the body, surrounded by a wide flattened projecting rim, bevelled on the edge (**Pl. 3b**).

This type is attested at Old Smyrna³³ and also among the finds from Sardis³⁴. In the Pontic area, some pieces have reached Berezan³⁵ and Histria³⁶.

Multicarinated lamps (type British Museum Q 374)

On these thin-walled angular-profiled models, the multicarinated body lies on a flat base and its somewhat concave shoulder is topped by a bevelled rim around the filling-hole. The slightly raising nozzle, neatly cut off, is attached on the shoulder of the oil container (**Pl. 3c**). These lamps generally bear a painted decoration of concentric fillets encircling the shoulder, whereas the lower body may be either plain or band-decorated. Instead, a flat bottom, the broader ones are sometimes fitted with a very high vertical funnel or solid shaft topped by a suspension ring.

²⁴ British-Turkish excavations 1948, unpublished.

²⁵ BOITANI 1971, p. 266 fig. 82, 273 n° 2194, 580/570-530-520.

²⁶ One single fragment from the Temple Area, unpublished.

²⁷ Hermitage B. 70-117, B. 84-204, B. 87-38.

²⁸ TECHNAU 1929, fig. 44 : 3 ; WALTER 1957, Beil 76 : 4 (2nd half of 6th cent.) ; FURTWÄNGLER 1989, p. 131 IIIc/8, fig 27, pl. 30 (ca. 545-535).

²⁹ BOITANI 1971, p. 266 fig. 82 N° 1555 (funnel), 3365, 785 (central cone) : type d (ca. 625 – 550/525).

³⁰ *Tocra I*, p. 141 fig. 68 n° 1431, pl. 90 n° 1431.

³¹ Hermitage B. 69-242, B. 71-256, B. 72-113, B. 72-115, B. 74-84, B. 76-108, B. 84-93, B. 84-96, B. 87-99, B. 89-41, B. 89-99, B. 89-102.

³² Several unpublished fragments from the Lambrino 1927-42 excavations and from the Temple area.

³³ British-Turkish 1948 excavations, unpublished.

³⁴ HANFMANN 1980, p. 131 fig. 30 ; GREENEWALT *et al.* 1987, p. 68 fig. 12, above, left.

³⁵ Hermitage B. 75-138, B. 76-124.

³⁶ Lambrino 1927-1942 excavations, unpublished.

Their distribution appears concentrated on the North Ionian sphere. They are particularly frequent among the finds of Old Smyrna³⁷ and Clazomenae³⁸. Further north, a single specimen from Assos in the Troas was discovered in a tomb dating back to the very beginning of the 6th century BC³⁹, whereas elsewhere only isolated finds have been reported, e.g., one from Naukratis⁴⁰, another one from Rhodos⁴¹ whereas in Ephesus one can assume that it might well be the type of lamp referred to as « candle-lamps » by Hogarth⁴². In the Pontic area, they seem to be represented by some occasional finds from Berezan, such as the one presented hereafter⁴³. One further specimen from Gravisca might well correspond to a more advanced stage of development⁴⁴.

Even if the chemical pattern of three samples from Old-Smyrna analyzed in Lyon rather points to a North-Ionian centre of manufacture distinct from Clazomenae (rather Erythrae than Teos), judging from the quite similar assemblage of such lamps among the finds from Clazomenae, one can assume that their area of manufacture embraced the major part of Northern Ionia.

Round-bodied black-glazed lamps with curled rim: distinct from Clazomenae

These lamps, dating back to the 2nd / 3rd quarters of the 6th century BC, have a rounded body, strongly curved inwards, and, usually, a pointed cone (**Pl. 1i**), though funnel variants are attested too (**Pl. 1j, 4c**). Their painted decoration consists in a band of dark brown / black glaze, more or less burnished and enhanced with white fillets on top, and in a central medallion of the same glaze, also with white fillets, on the central cone.

Carefully made, they have been widespread throughout the Mediterranean under several finishing standards. They are especially attested at Gravisca⁴⁵ and Tocræ⁴⁶.

In the Black Sea, they appear on a number of sites: at Berezan⁴⁷ (**Pl. 4a-c**) and Histria⁴⁸, but also on the Dnestr liman⁴⁹. Part of them are fitted with a horizontal

³⁷ AKURGAL 1983, colour pls. D and E1, pl. 123 ; id., *GRKT* 1987, colour pl. 13.

³⁸ ERSÖY 1993 : vol. text : p. 421-426 ; vol. pls. : pl. 54 : R 646, 61 : R 644-645, 75 : R 639-643 + variants pl. 194 : R 656, 198 : R 657, 236 : R 658.

³⁹ UTILI 1999, p. 124 fig. X (dated ca. 600-580).

⁴⁰ BAILEY 1975, p. 162, pl. 77 Nr Q 374 (wrongly attributed to Rhodes).

⁴¹ *ClaraRhodos* VI-VII, p. 538, fig. 76.

⁴² HOGARTH 1908, p. 39, 41, 236, 321.

⁴³ See below Hermitage B. 89-100.

⁴⁴ BOITANI 1971, p. 269 fig. 83 n° 1861, type e3.

⁴⁵ BOITANI 1971, p. 270 fig. 84, 282 fig. 89 n° 1827.

⁴⁶ *Tocræ* I, p. 141 fig. 68 n° 1429, Context III, Level 7 (ca. 565-520).

⁴⁷ Hermitage B. 69-121, B. 69-132, B. 73-320, B. 74-96, B. 76-120, B. 79-57, B. 84-95B. 89-103.

⁴⁸ DIMITRIU 1966, p. 483, pl. 51 (below, right).

⁴⁹ OKHOTNIKOV 1990, p. 21, photo 11: 8.

handle opposite to the nozzle⁵⁰; double-nozzled broader pieces with lateral handle have been distributed throughout the Black Sea⁵¹.

From the late Archaic period through the 5th century, part of them now rest upon a low flat raised base, most probably inspired by the new feature introduced by its Attic counterpart Howland's type 21B⁵².

The technique of most of these lamps recalls the fine Ionian cups of Villard B3 type, whereas the chemical pattern of two samples from Histria points to a North-Ionian centre of manufacture distinct from Clazomenae.

Lamps fitted with oversized devices: raised rod-handles & high-protruding funnels

Judging by an almost complete specimen from Berezan⁵³ (Pl. 4b) and fragmentary ones both from Berezan⁵⁴, Olbia⁵⁵ and Histria⁵⁶, various shapes of East Greek lamps were fitted with a high vertical rod-handle topped by a suspension loop⁵⁷; such a device, attested among the finds from Kyme⁵⁸ differs from the wider right through hollow high-funnelled earlier specimens of North-Ionian / Aeolian type from Bayraklı⁵⁹, topped with a wider basket-like handle over a carinated body. Whereas in the Black Sea area rod-handles seem mostly restricted to the Archaic period⁶⁰, the use of high-protruding funnels went on well until the Hellenistic period⁶¹.

The chemical pattern of one fragmentary loop-topped rod-handle of dull fabric from Histria points to a North-Ionian area of manufacture located distinct from Clazomenae somewhere between Erythrae and Teos.

⁵⁰ Hermitage B. 76-120 (from Berezan); DIMITRIU 1966, pl. 51, penultimate row r.

⁵¹ One unpublished specimen from Tariverde (Histrian chôra), enhanced with concentric white fillets around the edge of the rim and of the central cone, is exhibited in the museum of Histria. D.9. 5 cm.

⁵² HOWLAND 1958, p. 46-47, nrs. 164-170, pls. 6, 34.

⁵³ Odessa Archeological Museum, inv. OGIM A-37800.

⁵⁴ SHEIKO 2016, p. 85, fig. 5. Parallels put forward point to the interval 1st quarter 5th c. BC

⁵⁵ HØJTE 2010, vol. 1, p. 428-429, vol. 2 pls. 320-321 nrs. Q30-Q35 (late Archaic).

⁵⁶ DUPONT 2005b, p. 443 fig. 65: L 21.

⁵⁷ Histria, Temple area (HIS 1973/T, trench a), found together with Siana cup, Late Wild Goat and Fikellura fgts. Incidentally, such a morphological feature might well have inspired the appellation of « candle-lamps » formerly given by Hogarth to some unspecified shapes from Ephesus (HOGARTH 1908, p. 39, 41, 236, 321).

⁵⁸ HAKEN & MARSA 1974, p. 165-166, pl. 46, esp. L 4. The tentative dating of these four lamps in the 2nd c. BC appears rather debatable and the same remark applies to the collection of votive multi-nozzled ones from the same erratic location exhibited in the Archaeological Museum in Izmir, even if various Hellenistic specimens of high-funnelled and rod-handled lamps are actually attested elsewhere, either among the Agora series or among the finds from Crimea.

⁵⁹ AKURGAL 1983, pl. D above, (ca. 600 BC) E1 (end of 7th cent. BC).

⁶⁰ Even if Hellenistic specimens, assumed to be inspired from Knidian counterparts, still appear among the Agora finds. See HOWLAND 1958, p. 89 type 37D, nrs. 390-391, pls. 14 & 40 (« later years of 3rd down to ca. 150 BC »).

⁶¹ ZHURAVLEV *et al.* 2007, p. 166-168, nrs. 329-334 (Panticapaeum, late 4th-1st half 3rd c. BC).

Round-bodied common lamps with incurved rim

Concurrently with the preceding fine models, mass-produced common ones, not necessarily manufactured by the same centres, were widely distributed throughout the Mediterranean and the Black Sea, several types of which being quite well represented on sites as remote as Gravisca⁶² and Histria⁶³. Both models with central cone (**Pl. 1i**) or funneled ones (**Pl. 1j**) are concerned, sometimes two-nozzled, always without handle.

Our samples from Histria also revealed a North-Ionian chemical pattern.

Common lamps with incurved rim, central cone and pointed nozzle

Mostly small-sized, these simple-shaped lamps, without any decoration, were extremely widespread throughout the Greek world. They might have been manufactured almost anywhere, although in the Black Sea area they are most probably mainly originating from Eastern Greece or the Northern Aegean (**Pl. 4d**). In the Euxine, one colonial variant with concave base is frequent in Berezan⁶⁴ and Histria⁶⁵ (**Pl. 5c**).

Grey lamps with rounded or echinoid body

Most typical is a variety of average-sized two-nozzled shapes, with echinoid body, vaguely folded flattened rim and flat or slightly concave base, generally with lateral peak- arching handle, but some multi-nozzled specimens without handle are attested as well. Best characterized examples are those coated with a dark grey / blackish slip, often burnished, which are quite widespread on North-Pontic settlements, particularly at Berezan⁶⁶ (**Pl. 5b**) and Olbia⁶⁷, as well as at Panticapeum⁶⁸. Conversely, both in fabric and morphologically, the Bosporan series mostly differ from those of the Olbian area⁶⁹.

Particularly representative appears the complete range of variants brought to light from mid-6th century layers in the Demeter sanctuary of Nymphaion, among which some obviously overfired distorted specimens might well correspond to local products⁷⁰, as suggested by the discovery of a pottery kiln nearby⁷¹. More recently, quite an assortment of similar remains were excavated in Berezan itself⁷² and one can assume that these two distant Pontic fabrics of lamps were by no means isolated cases.

⁶² BOITANI 1971, 282 fig. 89: shapes quite similar to nrs. 11 and 244 are attested in Histria among Lambrino finds.

⁶³ Numerous unpublished fragments among the former Lambrino finds 1927-1942.

⁶⁴ Hermitage B. 67-159, B. 68-104, B. 75-139, B. 77-211, B. 83-285, B. 86-4...

⁶⁵ DIMITRIU 1966, p. 483 pl. 51 (below, l.).

⁶⁶ Hermitage B. 64-208, B. 85-149, B. 89-149, *et al.*

⁶⁷ KOZUB 1979, p. 20 fig. 15 (2nd l. from above).

⁶⁸ ZABELINA 1992, p. 300 pl. I: 1, 302.

⁶⁹ ZHURAVLEV *et al.* 2007, p. 148-164 cat. 289-327. Whereas the Bosporan specimens are generally dated 4th cent. BC, those from Berezan are more presumably issued from late archaic levels.

⁷⁰ KHUDYAK 1962, p. 44, pl. 37 :4.

⁷¹ KHUDYAK 1952, p. 244 fig. 7, 257 fig. 18 (1st. half 6th. c. BC).

⁷² KRUTILOV *et al.* 2017, p. 34, fig. 3.

The rest of the collection of grey lamps consists in smaller-sized single-nozzled models with rounded or echinoid body, flat base and without handle, all uncoated.

Lamps type Howland 19A

On these thin-walled funnelled lamps, the bowl of the oil container is unusually flattened and the flat rim very sharply folded inward⁷³ (Pl. 1g, 3d). They form a very homogenous group, with a single mesomphalic variant, attested both in Miletus and Histria. All of them or so seem to be double-nozzled. The finely micaceous, greyish beige to lightorange clay met on the standard variety contrasts with the fine orange one of the mesomphalic variant⁷⁴. Minor differences lie in their coating ranging from brush-painted orange beige slip to dull black glaze on the finest specimens. There is also what might be an additional glossy slipped finer variant with fine orange clay, narrower inward folded convex instead flat rim, connected to the lower body by a less pronounced folding (Pl. 3e).

These lamps were distributed during the last third of the 6th century BC and the first quarter of the 5th, except one single piece from Tocra reported to be from a context of doubtful earlier date⁷⁵. As for mainland Greece, except at Athens, where they might well have been imitated after Howland (type 19B), they were also found at Thorikos⁷⁶ and Ægina⁷⁷. However, the homeland of the standard Howland 19A remains unclear. They are pretty well attested among the finds from Samothrace⁷⁸ and, more generally, from the Northern Aegean (Thasos⁷⁹, Olynthus⁸⁰, Troy⁸¹ *et al.*) (Pl. 3d), whereas in Eastern Greece itself their presence seems to have been rather sporadic⁸² or at best in a minority⁸³.

Conversely, they are extremely frequent throughout the Black Sea area on most West- and North-Pontic sites: in Histria⁸⁴, on the Dnestr liman (Tyras⁸⁵,

⁷³ HOWLAND 1958, p. 39-40 type 19A, pl. 5, 33 cat. 131-135.

⁷⁴ Hermitage B. 77-74 (from Berezan), as well as some fragments from Histria (Lambrino excavations 1927-1942, unpublished).

⁷⁵ *Tocra* II, p. 65 fig. 26 cat. 2271: Context II, Level 8 (ca. 590-ca. 565).

⁷⁶ BLONDÉ 1983, p. 56-59, fig. 4 n° 25-33.

⁷⁷ FURTWÄNGLER 1906, pl. 130 n° 9 (above r.); BAILEY 1991, p. 59, n° 182-188, 61 fig. 47 n° 173, 180.

⁷⁸ LEHMANN 1962, p. 149, cat. 93-96.

⁷⁹ GRANDJEAN 1988, pl. 73 : 1.

⁸⁰ ROBINSON 1952, p. 340-342, pl. 144 : 2.

⁸¹ BARR 1996, p. 162 fig. 1 : 5 et 2 : 5.

⁸² BLINKENBERG 1931, col. 615 et pl. 122 n° 2557 (Lindos) ; ERSÖY 1993, pl. 133 : R 649 (Clazomenae) ; GENÇLER GÜRAY 2018, p. 39 (type 2), 48 fig. 3 : 1 (Erythrae). Isolated pieces also came to light on Lesbos Island, both from Mytilene and Methymna (kind information H. Williams)

⁸³ In Miletus the shape is represented among the finds from Kalabaktepe by a few specimens of the standard funnelled type and of a mesomphalic variant, respectively recorded under the labels Type X : A and B : « Lampen mit nach innen geneigten Rand » (courtesy Selesnow, Milet-Akköy archive 2004).

⁸⁴ It seems to be the predominant late archaic shape of lamp among the still unpublished finds of the Lambrino excavations.

⁸⁵ ZABELINA 1987, p. 109 (type II), 112 fig. 3 : 2.

Nikonion, Nadlimanskoe 3⁸⁶ *et al.*), at Berezan⁸⁷, Olbia⁸⁸ and its *chôra*, Panticapeum and Cimmerian Bosporus⁸⁹ *et al.* The type also gave rise to local imitations as lab evidenced on one sample from Histria.

As for their attribution of origin, lab results clearly rule out Howland's tentative assumption of a Rhodian manufacture, they still appear rather confusing at the present stage. When compared with our data-bank for Eastern Greece, the rather homogenous chemical pattern of what seems to be the main cluster - instead group proper - of our samples of Howland 19A type from Histria overlaps those of two distinct centres of manufacture, viz. one of our Clazomenian sub-groups and one of our Milesian ones. In the first case, though including some wasters of transport amphoras from the island workshops, the attribution seems hardly convincing indeed, as not supported by the local assemblage of finds⁹⁰. More attractive at first sight would appear the latter possibility, because various specimens of lamps of Howland's 19A type are actually recorded among the new finds from Miletus, both the main standard shape with central funnel and its omphalos variant, but in a minority among the wide range of other shapes of South-Ionian types from Kalabak Tepe⁹¹. Conversely, when extended to the neighbouring North-Aegean area, the data processing more clearly points to Thasos Island, at least for the canonical series, in that case fully in accordance with the local assemblage of finds⁹². We are quite obviously faced with a partial overlapping of chemical pattern between these three distant regions. In the case an attribution to Thasos will be validated, the late Archaic dating of these lamps of Howland 19A type⁹³ would thus coincide with the Pontic distribution of the first series of transport amphoras of North-Aegean origin and explain their higher frequency among the finds from North-Eastern Euxine settlements, such as Panticapaeum, Mirmekion...⁹⁴, of later foundation dates than Berezan. But such an attribution is still only at the stage of working hypothesis. Beside this main cluster of standard samples of Howland 19A type, two other specimens from Histria, belonging to the mesomphalic variant, clearly fall into a separate chemical North-Ionian group (Erythrae ?), three others share the same Aeolian chemical pattern as our samples of Myrina figurines, whereas a thicker last one from Histria, made of fine light clay with orange beige slip, clearly corresponds to a local imitation.

⁸⁶ OKHOTNIKOV 1990, 21, photo 11 : 4, 6.

⁸⁷ Hermitage B. 67-104, B. 67-110, B. 79-58, B. 82-76, B. 85-146, B. 87-36.

⁸⁸ *Ol'vii. Temenos i Agora* 1964, fig. 4: 2; KOZUB 1979, p. 20 fig. 15 (above l.).

⁸⁹ ZABELINA 1992, p. 305, pl. II : 4 ; ZHURAVLEV *et al.* 2007, p. 31-37 nrs. 1-17 (c. 525-480 BC).

⁹⁰ ERSÖY 1993, txt. p. 424-425, pl. 133 (one single find).

⁹¹ See above, note 82.

⁹² I am indebted for this piece of information to my colleagues J.-J. Maffre and M. Perron.

⁹³ One single assumed earlier find of lamp of Howland 19A type seems cautiously reported only in Tocra (see *Tocra* II, p. 64-65, fig. 26, cat. nr. 2271 (Deposit II, Level 8, c. 590-565 BC).

⁹⁴ ZHURAVLEV *et al.* 2007, p. 31-37 cat. 1-16.

Lamps with central cone and narrow concave rim sharply sloping inwards

On these small-sized models, erroneously classified as variants of Howland's type 19, the limit between the upper part of the body and the rim marked by a sharp ridge (**Pl. 1h**). The painted decoration, rather simple, is most of the time restricted to a narrow band or to fillets on the edge of the rim; the nozzle also painted by dipping.

From Eastern Greece, one specimen from Lindos was published by Blinkenberg⁹⁵. In the Black Sea area, several unpublished fragmentary pieces from the former Lambrino excavations in Histria, one of which with more elaborated painted decoration, where the central cone itself receives a touch of brown paint surrounded by two concentric fillets; on another specimen from Histria, the rim even bears an additional double fillet in white paint. Similar pieces have been found at Berezan⁹⁶ and Nikonion⁹⁷.

Open straight-flanged lamps, with inward thickened rim

These are simple models with painted decoration restricted to the nozzle by dipping; they are almost straight flanged and the rim is only slightly bulging inward. The most significant specimen, with central funnel, came out at Berezan and develops all around the incised circumstantial inscription: « *As I am a lamp, I provide light as well to gods as to men* »⁹⁸ a verse referred to Hipponax of Ephesus (2nd half of 6th c. BC).

Thick open lamps, straight flanged, with flattened rim

Often big-sized and multi-nozzled, with a thick rim flattened on top, they include shapes with central cone as well as high funneled others, some of which topped by a hanging ring⁹⁹. The nozzle is painted by dipping and concentric fillets ornate the flattened part of the rim.

In the Mediterranean area, the shape seems attested at Gravisca¹⁰⁰ and Naucratis¹⁰¹. Similar pieces seem to have circulated in the Black Sea, to judge by some finds from Berezan¹⁰² and, possibly too, from Chersonesus¹⁰³. On the models fitted with three nozzles (Berezan), each of them can be flanked by a pair of vertical lugs (**Pl. 6a**).

Multi-storeyed candelabra

Under this appellation are meant multi-nozzled lamps comparable to the

⁹⁵ BLINKENBERG 1931, pl. 121 n° 2550.

⁹⁶ Hermitage B.63-152.

⁹⁷ SEKERSKAYA 1989, pl. 18: 8.

⁹⁸ PHARMAKOVSKY 1910 – B. Pharmakovsky, 'Archäologische Funde im Jahre 1909. Russland', AA 1910, col 226-227 fig. 26, SOLOVYOV 2005, p. 141 n° 268.

⁹⁹ HAKEN & MARSA 1974, p. 165-166, pl. 46.

¹⁰⁰ BOITANI 1971, p. 269 fig. 83 and 87 n° 15: type e3 (2nd half 6th- beginning 5th cent. BC).

¹⁰¹ Cambridge, Mus. of Class. Archaeology, NA. 254, unpublished.

¹⁰² Hermitage B. 76-270.

¹⁰³ BELOV 1972, p. 57 fig. 10.

ones first reported at Selinus¹⁰⁴, where the rows of nozzles are storeyed on three levels. Such candelabra, more or less functional, seem related to these fenestrated *thymiateria* found on several sites of North Ionia (viz Old Smyrna) and Aeolis (Larisa) were often associated to cultual practices. In the Black Sea area, no archaic pieces seem attested as yet, but one quite impressive five storeyed specimen of late Hellenistic date was brought to light in a sanctuary near Patrasys (Taman peninsula)¹⁰⁵ (Pl. 6b).

A minor variant of these impressive candelabra is represented by single-storeyed multinozzled lamps with vertical plain or hollowed handle topped by a suspension ring, several specimens of which were found in Kyme¹⁰⁶. Such lamps are generally thought to be connected with cult practices too¹⁰⁷. Their dating in the Hellenistic period at Kyme seems rather doubtful: straight-flanged lamps with folded rim of similar profile are well attested too during the archaic period.

No specimen at all is to be mentioned among the Hermitage collection of Berezan lamps.

Locally made lamps from NW-Pontic workshops

Not at all surprisingly, in addition to vases, North-West Pontic workshops surely produced various imitations of wheel-made lamps imitating the range of shapes of their mother-cities. Their pale beige shade of clay (loess) seems very close to that of some series of common wares distributed among North-West Pontic settlements. In Berezan itself, such replicas have been recently evidenced by kiln-wasters of Archaic date¹⁰⁸.

Widespread seems to be a variety of thin-walled shapes characterized by their raised rim and widely open bowl, with various shades of pale clay. Several specimens of lamps of similar shape and fabric came to light in Berezan¹⁰⁹ as well as in Histria¹¹⁰ and Nikonion¹¹¹. The chemical pattern of the specimen from Histria falls into a group of still unlocated Pontic origin together with three other fragments of Archaic lamps (viz. two from Histria & one from Berezan) of various shapes suggesting that we are probably faced with the products of a specialized workshop.

As for the grey lamps, of which one can assume that quite a lot were most probably locally made, a particular attention must be devoted to an impressive three-nozzled specimen¹¹², made of especially pale clay.

Occasional imitations or imports of Mainland Greek types?

Some isolated shapes of Archaic lamps from Berezan seemingly depart from

¹⁰⁴ GABRICI 1927, col. 371-372 fig. 123.

¹⁰⁵ ZHURAVLEV & ZAVOIKIN 2004, p. 195 fig. 1.

¹⁰⁶ HAKEN & MARSA 1974, p. 165-166, fig. 1, pl. 46 (L 1- L 4).

¹⁰⁷ See PARISINO 1997.

¹⁰⁸ KRUTILOV *et al.* 2017, p. 34 fig. 3 (from kiln 24).

¹⁰⁹ Hermitage B.368, B. 72-112B. 82-177.

¹¹⁰ Lambrino excavations 1927-1942, B. 1542, unpublished.

¹¹¹ Numerous unpublished fragments in the Archeological Museum, Odessa. We are indebted to N. M. Sekerskaya for having allowed us to see her finds.

¹¹² Hermitage B. 76-270.

the standard East Greek lineage. Part of them are obviously connected with the Corinthian sphere by shape¹¹³ though not really in fabric, judging from their a bit more coloured clay than the standard yellowish originals. As for the other variety involved, it both morphologically and in fabric recalls the Attic lineage¹¹⁴, but both its paler orange clay and misfired black glaze in comparison with the originals lead to assume the possibility of North-Pontic imitations.

Native handmade open lamps

In closing this brief overview of the Ionian lamps distributed throughout the Black Sea, it is worth mentioning a range of small handmade lamps of various shapes¹¹⁵ (Pl. 6c), most of the time to be interpreted as autochthonous imitations, either Getic or Scythian¹¹⁶ depending on the place of discovery, but which, for at least part of them, might well have been manufactured by Greek (or Mixhellenic?) workshops too¹¹⁷.

- § -

Thus, the Greek settlements of the Black Sea provide us a comprehensive and presumably quite representative overview of the main types of lamps distributed by the exporting centres of manufacture of both Eastern Greece and the Northern Aegean throughout the archaic period, from the earlier thick carinated shapes till the late archaic thin-walled models with inwards folded or incurved rim. It is on these mass-produced and widespread models that archaeometric studies must give priority on, rather than scatter expensive efforts on products of secondary importance or isolated oddities.

At the level of history of technology, an interesting closely related problem lies in a certain degeneration of these colonial products compared with the imported originals. A thorough study would allow us to evaluate to what extent the obvious lower standard of manufacture is connected with the colonial context (lower quality of the available clay sources, lower skill of the immigrant potters or even, in some cases, ethnic origin of the potters, or if we would not be actually faced more simply with second rate products, of the same poorer standard as those of the minor non-exporting East Greek workshops, many lesser skilled potters of which might have deliberately chosen to settle abroad. As, in all probability, non-specialized workshops were here involved, presumably the colonial potters tried, as in the case of the common pottery, to satisfy the tastes of the predominant mass of customers, originating rather from the North-Ionian and Aeolian cities than from South Ionia, first of all from Miletus. As for the imports

¹¹³ For them, the reference type appears to be Howland's 16A, characterized by its swollen body topped by a broad flattened rim projecting outwards and covering the interval early 6th through 3rd quarter 6th c. BC.

¹¹⁴ Viz. Howland's type 16 B, assumed to be an Athenian, black-glazed adaptation of Corinthian 16A, thus a little later, namely the late 6th and the early 5th c. BC

¹¹⁵ WALDHAUER 1914, pl. I: 1-8.

¹¹⁶ MARCHENKO 1988, p. 101 fig. 32: 5, 6, 11; MALYUKEVICH & PRISYAZHNYUK 2000, p. 154-162.

¹¹⁷ It is probably the case for some finds from the Temple area at Histria.

originating from Eastern Greece and the northern Aegean, it is highly likely that at least one part of them were made by specialized workshops, first of all the so-called « Samian » lamps and those of type Howland 19A, both mass-produced. Another piece of evidence in favour of a certain specialization of the exporting workshops lies in the fact that these archaic East Greek lamps were predominantly made of calcareous clays as compared with the vases produced by the same workshops, a choice deliberately intended to meet technical requirements.

Future research will also have to focus thoroughly on the distribution process of these Ionian lamps on the export markets, in comparison with the distribution of other common wares, such as the Ionian bowls and Ionian cups, the kitchen ware and transport-amphoras.

POST-ARCHAIC BEREZAN LAMPS: PRELIMINARY LAB APPROACH

As it seems henceforth established that the dual Berezan-Olbia was spared by the general upheaval which struck the whole North-Pontic area at the beginning of the 5th century BC¹¹⁸, the chronological implications for the Hermitage collection of lamps from Berezan now invite to reconsider their assumed confinement to the Archaic period alone, apart from two obvious Roman intrusions.

However, in the case of such a peripheral Ionian foundation as Berezan, considering the specificity of the East Greek ceramic repertoire, still rather blurred for the Classical period, as compared with the Attic one, universally used as typological reference, this leads us to tread as it were on uncertain ground.

The first shapes to be aimed at are some of those resting on a raised base, even if such a morphological feature by no means constitutes a secure enough criterion for post-archaic dating. An illustrative example is represented by the case of chimney lamps with central funnel much taller than usual: our raised-based specimen B.66-144 from Berezan might be put together with a 5th c. BC counterpart from Troy of Howland 22A type¹¹⁹ or with a later deep-bowled parallel of Howland 26A¹²⁰, also attested in the Berezan area¹²¹, without mentioning high-funnelled later ones without raised base from Panticapaeum issued from contexts covering the interval late 4th / 1st half of 3rd c. BC¹²².

Concerning grey lamps proper, a special case is represented here by the specimen B-66-158, the shape of which differs completely from the whole range of

¹¹⁸ SOLOVYOV 1999, esp. p. 98-113.

¹¹⁹ BARR 1996, p. 163 fig. 4: 12 & p. 166 nr. 11.

¹²⁰ HOWLAND 1958, Type 26A, p. 85-86, nrs. 365-371, pl. 13, 40 (2nd quarter 4th through early 3rd c. BC).

¹²¹ SHEIKO 2014, esp. p. 405 fig. 3: 3, 408 fig. 6: 2.

¹²² ZHURAVLEV *et al.* 2007, p. 166-168 Nr. 329-334.

Archaic Greek shapes attested among the Berezan finds. The only morphological parallel seems to be found in a rare variety of the Agora repertory, viz. Howland's type 36A of weak dating in the 2nd half of the 4th century BC.

Last but not least, two Roman intrusions somewhat unexpectedly swelled the collection, viz. B. 479 and B. 69-235, though not of contemporaneous dating: the former dating back to the 2nd century AD and the latter to the interval 3rd/4th centuries AD.

CANDLESTICKS PRECURSORS ?

Three items of the Berezan collection (**Pl. 39**), though not recorded as lamps, stand out by their unusual features¹²³, viz. a central tube much stronger and thick-walled than on the standard « *Stocklampen* »; above all, instead piercing the bottom of the bowl right through, it presents at the base two diametrically opposite openings, either circular or quadrangular holes for two of them, two similarly opposite notches for the third one; on two of these pieces the upper edge of the central tube is encrusted with soot. Such peculiarities, even if they do not correspond at all with those of conventional oil lamps of Greek type, point to their interpretation as lighting devices, despite the fact that only one of them - B. 87-106 - seems clearly falling into the Greek period, viz the end of the 5th or the beginning of the 4th century BC¹²⁴. Considering the fact that the Northern Euxine was at that time a major native producer of solid fats such as tallow one can reasonably assume that we are faced here with tallow lamps instead of oil lamps and that their special features are intended for fitting in candles¹²⁵. As during the medieval period, these tallow candles were probably fitted with flax or hempen wicks¹²⁶.

On the Northern Black Sea area, the daily diet of the Scythians was based on mutton, beef and horse meat and they used to produce butter in churning mare milk¹²⁷; on the Western part, the Thracians were famous horse breeders¹²⁸; and, on the Southern shore, Xenophon, when crossing the territory of the barbarian tribe of Mossynechoi, reports that they are using dolphin fat in the same manner as the Greeks use olive oil¹²⁹. All these barbarian tribes devoted to cattle or/and horse breeding were quite well trained to deal with solid fat products and might

¹²³ Hermitage B. 63-234, B. 87-11 and B. 88-44.

¹²⁴ As excavated from semi-dugout 48 (see. SOLOVYOV 1995). The second specimen - B. 63-234 - was found together with a grey lamp of orthodox Greek type - B. 63-226 - but issued from a less clear context. As for the third one - B. 88-44 -, it was unearthed from a less conclusive superficial layer.

¹²⁵ See DUPONT 2019 for fuller account.

¹²⁶ About candles in antiquity, FORBES 1966, esp. p. 140: « *the home of the candle seems to have been Italy, its use going back to the Etruscans... From Rome the candle went east to Greece, at a fairly late date* ». For a comprehensive approach of tallow processing and candle manufacture, see: LE NORMAND 1828.

¹²⁷ Herodotus IV, 2.

¹²⁸ Strabo, VII, 3, 2

¹²⁹ Xenophon, *Anab.*, V, 4, 28

have transmitted to the Hellenic newcomers their skill in this field, leading the Greek colonists to innovate in adapting occasionally, as early as the Archaic period, their oil lamps to solid fuels such as tallow or even its manufactured by-product the candle, so requiring a specific stand: the candlestick. Olbia was also exporting bees-wax throughout the Roman Empire¹³⁰ and was most presumably producing it long before. Without going as far as to interpret these three pieces as kerosene lamps precursors, it is also worth mentioning that surface overflows of naphtha are to be found in great quantities both on the Kerch and the opposite Taman peninsulae and that this sort of fuel was already in use in the North-Pontic sphere, if not for domestic at least for external lighting during antiquity¹³¹. However, the use of liquid bitumen for lighting in the case of ancient Berezan appears more questionable, for lack of local naphtha resources in the opposite Olbia region.

In the case this interpretation proved to be true, so these three odd lighting devices would appear to be the earliest obvious evidence of the use of tallow candles by the ancient Greeks¹³², even a little earlier as those allegedly depicted on the Golini 1 tomb frescoes in Orvieto¹³³.

¹³⁰ Juvenal, III. 267; Martial, XIV. 40.

¹³¹ Apart from a transport amphora of 5th/6th century AD date, discovered in Tyritake in 1939, which was filled of liquid bitumen, authenticated by chemical analyse (USPENKII 1952), another much earlier one of Zeest's « Protothasian » type, reused for naphtha content, was recently found on a rural settlement of the Taman peninsula (information kindly provided by S. Solovyov), which attests that the local use of bitumen even goes back to the the late Archaic period in this area, where it was still in use by the natives for lighting till the end of the 18th century (OBRUCHEV 1921, p. 181, 201), though in what kind of lighting device remains unclear. On the use of mineral fuels for lighting purposes during the Greek and Roman periods, see Plinius, *Nat.Hist.* II, 108-109; FORBES 1955, p. 84. As for Illyria, see also VREKAJ 2004.

¹³² Unfortunately, chronological reliable data on their contexts of finding are hardly available but for B. 87-106, from semi-dugout 48, in use during the span late 5th-first decade of 4th cent. BC. See SOLOVYOV 1999, p. 105-108.

¹³³ FORBES 1966, p. 140, refers to an Etruscan tomb painting from Orvieto, depicting burning candles in white, fitted on the branches of candelabra bringing light to a dining room. In the meanwhile, this tomb – so-called Golini I – has been dated accurately ca. 400-330/320 BC. As the matter of fact, the interpretation as candles appears hardly convincing: simply pin up halfway up against the candelabrum and without candle rings to collect tallow trickling such candles would have been quite unfunctional indeed, whereas such an arrangement might well fit with fackles, which were not only moveable but also on fixed stands as in the palace of Alkinoos (*Od.*, VII, 101). However, such a distinction is pointless, because fackles were not made only of resinous wood, but also of hemp rope or tow coated with tallow or wax.

ARCHAIC EAST GREEK LAMPS: PRELIMINARY LAB APPROACH

The Lyon Lab data bank includes the chemical results of some 56 representative samples of Archaic East Greek lamps, most of them from Pontic settlements, viz. 39 from Histria, 4 from Berezan, 7 from Old Smyrna, 2 from Samos, one from Miletus, one from Thasos and 2 from Naukratis. Even if much more sampling would be required, some general guidelines already emerge from their processing.

A first one seems to be that the general sequence of chemical patterns of these lamps might well be not strictly modelled on that of vases and transport amphoras when compared with our network of local references for Eastern Greece. A possible explanation may lie in the fact that, even if these Ionian lamps were all wheelmade, at least part of them were made in specialized distinct workshops using distinct clays or appropriate blendings of clays as for the manufacture of moulded terracotta figurines or plastic vases. Maybe in support of such a possibility, the fact that the chemical pattern of two of our samples of lamps from Histria ascribable to Aeolis matches up more closely with the one of our samples of terracotta figurines from Myrina suggests that some of them might well have been made by the local workshops of coroplaths using clays or clay mixtures of distinct chemical pattern as for common ware, judging from the results of our comparative tests.

As in the case of the Wild Goat style formerly mostly attributed to Rhodian workshops on the basis of Camiros and Ialysos finds, it appears that the major role attributed to Samos Island on the basis of Heraion finds in the manufacture and overseas distribution of Ionian lamps looks far from a reality. Judging from Black Sea finds, the leading part seems to have been played by North-Ionian / Aeolian workshops and at a much lesser degree by Milesian ones, completed by colonial imitations. Also noteworthy appears the somewhat unexpected possible leading role of Thasos in the manufacture and Pontic distribution of lamps of Howland 19A type of Late Archaic date.

CATALOGUE

Ermitage Inventory Nr.
Field Inventory Nr.
Description

Carinated « Samian » type or related : chimney type

B. 64-106 [Fig. 1 ; Pl. 7]

Ber. 64-283

D. max. 8. 3 ; D. rim 8. 8 ; H. bowl 2. 1 ; H. funnel 2. 2

Slightly carinated chimney lamp with echinoid body, slanting funnel, slightly projecting triangular rim flattened on top and raising nozzle. Nearly complete except one scrap of lower bowl. Orange beige clay, paler outside, finely micaceous, shimmering. Brush-painted brick-red glaze inside whole bowl and on top of rim and nozzle. Found together with Laconian globular aryballos and G2/3 (?) ware.

From : Sector Γ, pit 10 (pottery assemblage 6th/5th c. BC).

Parallels : KOPCKE 1968, p. 272 fig. 22a-b (« vor 570-560 »).

B. 67-163 [Fig. 1 ; Pls. 2c & 7]

Ber. 67-116

D. max. 9. 3 ; D. rim 8. 2 ; H. bowl 2. 1 ; H. funnel 2. 4

Big carinated chimney lamp with concave shoulder, slightly everted rim sharply edged and slanting, slightly protruding funnel. Large part of bowl, rim and whole nozzle missing. Orange beige clay, paler outside (selfslip), very micaceous and shimmering. No traces of paint. Slight traces of soot around the ridge of bowl. Standard « Samian » type.

From : Sector Γ, occupation layer (sic!).

Parallels : KOPCKE 1968, p. 272 fig. 22b, d, pl. 105 : 2, 4 (« vor 570-560 »).

B. 69-244 [Fig. 1 ; Pl. 7]

Ber. 69-303

D. max. 10. 0 ; D. rim 8. 4 ; H. bowl 2. 3 ; H. funnel 2. 2

Thin-walled carinated chimney lamp with slanting funnel and gently everted rim. Upper part of bowl largely missing as well as nozzle.. Orange beige clay, purplish at core, paler outside, finely micaceous with scattered mica flakes and numerous lime inclusions. Standard « Samian » type.

From : Sector Γ, well Nr. 3 (pottery assemblage mid 7th (sic!) / 1st half of 6th c. BC).

Parallels : KOPCKE 1968, p. 272 fig. 22b, d (« vor 570-560 »).

B. 70-206 [Fig. 1 ; Pls. 2b & 7]

Ber. 70-350

D. max. 9. 0 ; D. rim 8. 2 ; L. with nozzle 10. 9 ; H. body 2. 3 ; H. funnel 2. 6

Gently carinated chimney lamp, with beak-shaped rim and two stamped circles on either side of the nozzle. Nearly complete but badly weathered. Bright orange clay, darker at core, finely micaceous, shimmering. No glaze. Traces of soot around nozzle and adjoining parts of rim. Standard « Samian » type.

From: fortuitous discovery at the southern edge of the settlement.

Parallels: KOPCKE 1968, 272 fig. 22a (vor 570-560); KASSAB & SEZER 1995, 752 nr.9 + figs. (Ephesus, 2nd quarter 6th cent. BC).

B. 71-253 [Fig. 2 ; Pl. 7]

Ber. 71-17

D. max. 7. 9 ; D. rim 7. 8 ; H body 2. 4 ; H. funnel 2. 1

Carinated chimney lamp with everted gutter rim. Part of bowl and rim with nozzle missing. Orange beige clay, paler outside (self-slip), very micaceous, shimmering. Standard « Samian » type.

From: NW Sector, occupation layer (sic!).

Parallels: KOPCKE 1968, 274 fig. 23k-1; FURTWÄNGLER 1989, 115 I/33, 118 fig. 22pl. 24 (ca. 590-570).

B. 71-254 [Fig. 2 ; Pl. 7]

Ber. 71-18

D. max. 8.25 ; D. rim 8. 1 ; H. body

Supposedly chimney lamp with everted gutter rim. Greater part of bowl and rim missing. Orange buff clay, paler outside, very micaceous, shimmering. Traces of soot at tip of nozzle. Standard « Samian » type ?

From: NW Sector, occupation layer (sic!).

Parallels: cf. B. 71-253.

B. 73-265 [Fig. 2 ; Pl. 8]

Ber. 73-15.

D. max. ca. 9. 0 ; D. rim 8. 2 ; D. funnel (top) 2. 0 ; H. bowl 2. 4 ; H. funnel 2. 4

Carinated chimney lamp with slightly everted gutter rim and slanting funnel (standard « Samian » type). Very eroded and weathered. One part of bowl and rim missing ; end of nozzle broken. Pale orange beige clay, very micaceous (flakes) and shimmering. Unpainted. Important traces of soot around nozzle and on top of rim and funnel.

From: NW Sector, sq. 14, recess (pottery assemblage mid / 3rd quarter 6th c. BC).

Parallels: KOPCKE 1968, 274 fig. 23h-i (« vor

B. 77-208 [Fig. 2 ; Pls. 2a & 8]

Ber. 77-69

D. max. 9. 1 ; D. rim 8. 0 ; H. bowl 2. 5 ; H. funnel 2. 5

Sharp carinated chimney lamp with concave shoulder and upright gutter rim. Nearly complete except small fragments of bottom, funnel, shoulder and rim. Dark orange beige clay might buff outside (self-slip), very micaceous, highly shimmering. Remains of soot around nozzle. Standard « Samian » type.

From: NW Sector, sq. 22, dugout 2 (pottery assemblage 1st half to mid-6th c. BC).

Parallels: GALLI 2004, pl. 3 nr. 35 (type 5a, ca. 600-550).

B. 77-209 [Fig. 2 ; Pl. 8]

Ber. 77-70

D. max. 8. 3 ; D. rim 7. 85 ; H. body 2. 4 ; H. funnel 2. 45

Carinated chimney lamp with broad flat rim slightly projecting and slanting inward. One section of bowl and rim with nozzle missing. Dark orange clay, purplish grey at core, light buff outside (self-slip), very micaceous, highly shimmering. Remains of soot around nozzle. Standard « Samian » type.

From: NW Sector, sq. 22, dugout 2 (pottery assemblage 1st half to mid-6th c. BC).

Parallels: GALLI 2004, pl. 3 nr. 36 (type 5b, ca. 600-550).

B. 78-79 [Fig. 3 ; Pl. 8]

Ber. 78-124

D. max 8. 9 ; D. rim 6. 7 ; H. body 2. 6 ; H. funnel 2. 2

Blunt carinated chimney lamp with slightly everted gutter rim and nearly cylindrical central tube. Nozzle missing. Very micaceous, shimmering orange clay, purplish at core, pale buff outside (self-slip).

From: NW Sector, sq. 48, semi-dugout 7 (pottery assemblage 1st half of 6th c. BC).

Parallels: FURTWÄNGLER 1989, 115 : I/33, 118 fig. 22, pl. 24 (ca. 590 / 570).

B. 84-203 [Fig. 3 ; Pl. 9]

Ber. 84-324

D. max 8. 0 ; D. rim 7. 7 ; H. body 2. 4 ; H. chimney 2. 2

Blunt carinated chimney lamp with slightly everted gutter rim and sloping chimney. Broad segment of rim and bowl missing. High orange clay, orange beige at core, pale buff outside (self slip), finely micaceous, shimmering.

From: NW Sector, Pit 29 (pottery assemblage 1st half / 3rd quarter 6th c. BC).

Parallels: FURTWÄNGLER 1989, 122 : II/11, 121 fig. 23, pl. 26 (ca. 570 / 550 BC)

B. 85-74 [Fig. 3 ; Pl. 9]

Ber. 85-58

D. max. 8. 4 ; D. rim 8.3 ; L. with nozzle 10. 1 ; D. funnel 2. 4 ; H. body 2. 7

Gently carinated chimney lamp with narrow offset rim. Large part of rim and bowl as well as upper part of funnel broken. Purplish orange clay, very micaceous (flakes). Light buff surface, very micaceous too. Traces of soot around nozzle and bordering rim. Variant of "Samian" type?

From: NW Sector, occupation layer (sic!).

Parallels: KOPCKE 1968, 272 fig. 22a (before 570/560) ; *Tocra* I (1966), 141 fig. 68 nr. 1432.

B. 89-101 [Fig. 3 ; Pl. 9]

Ber. 89-128

D. max. 8. 4 ; D.rim 7. 4 ; H. bowl 2. 4 ; pres. H. funnel 2. 0

Carinated chimney lamp with slanting funnel and slightly projecting gutter rim. Most part of bowl, funnel and rim missing. Orange beige clay, light buff outside, purplish at core, finely micaceous, shimmering. No glaze remains.

Important traces of soot around nozzle and nearby part of rim. Standard « Samian » type.

From : NW Sector, sq. 712, recess (pottery assemblage (early ?) 1st quarter 6th c. BC).

Parallels : KOPCKE 1968, 272 fig. 22^e (vor 570-560), 273 fig. 23i.

Carinated « Samian » lamps or related: mesomphalos type

B. 63-155 [Fig. 4 ; Pl. 10]

Ber. 63-216

D. max. 7. 5 ; D. rim 7. 0 ; H. bowl 2. 65

Small sharply carinated lamp, with concave shoulder, central cone and grooved rim, sharply edged outside. Two thirds of bowl and rim with nozzle missing. Orange clay, paler near surface, sparingly micaceous. No glaze. Traces of soot on rim.

From : W Sector, occupation layer (sic!).

Parallels : GALLI 2004, pl. 3 nr. 40 (type 5b, ca. 600-550).

B. 78-77 [Fig. 4 ; Pl. 10]

Ber. 78-86

D. max 7. 3 ; D. rim 7. 2 ; H. bowl 2. 2 ; H. cone 2. 2

Gently carinated lamp with hollowed central cone and slightly projecting cornice rim inward slanting. Nozzle and half of the bowl missing. Orange beige / buff clay, greyish at core, finely micaceous, shimmering.

From : NW Sector, sq. 46, occupation layer (sic!).

Comparenda : GALLI 2004, pl. 4 nr. 58, 60 (type 5e, ca. 575-525).

B. 84-204 [Fig. 4 ; Pl. 10]

Ber. 84-325

D. max 9.3 ; D. rim 8. 3 ; H body 8. 3 ; H. cone 3. 2

Neatly carinated lamp with narrow offset rim and protruding hollowed central cone. Nozzle and segment of rim and bowl missing. Pale orange clay, light grey at core, pale buff outside, finely micaceous (self-slip).

From : NW Sector, Pit 29 (pottery assemblage 1st half / 3rd quarter 6th c. BC).

Parallels : same bowl profile with narrow rim as the chimney piece KOPCKE 1968, 272 fig. 22a (before 570 / 560 BC) ; same protruding hollowed cone as GALLI 2004, pl. 3 nr. 51 (type 5c, ca. 575 – 525).

B. 87-38 [Fig. 4] ; Pl.10]

Ber. 87-147

D. max 8. 8 ; D. rim 8. 1 ; H. bowl 2. 6 ; H. cone 3. 5

Thin-walled lamp with narrow slightly projecting rim and protruding central cone. Most part of nozzle and segment of rim and bowl missing. Orange clay, light grey at core, orange beige outside (selfslip), finely micaceous. Remains of brown glaze around base of nozzle and on next part of rim. Traces of soot on rim opposite to the (missing) nozzle. Variant of « Samian » type ?

From : NW Sector, House 4 (pottery assemblage late Archaic to early Classical).

Parallels : KASSAB & SEZER 1995, nr. 91 (« end of 6th cent. BC, Ephesian workshop »).

Thick-walled carinated lamps : chimney type

B. 69-242 ; Pl.11]

Ber. 69-243

D. max. 9. 5 ; D. rim 8. 5 ; H. body 2. 25

Carinated chimney lamp with thick inward slanting flattened rim, edged by a thin fillet on either side. Most part of bowl, funnel and rim as well as nozzle missing. Orange beige clay, paler outside, greyish beige at core, sparingly micaceous (scattered fine mica flakes). Brush-painted diluted brown glaze inside bowl, slightly overlapping on inner rim fillet ; nozzle glazed by dipping.

From : context unspecified.

Parallels : GALLI 2004, pl. 3 nr. 41, 45, 47 (type 5c, ca. 575-525).

B. 72-115 [Fig. 5 ; Pl. 11]

Ber. 72-160

D. max. 9. 1 ; D. rim 8. 4 ; H. body 2. 1 ; H. funnel 2. 5

Carinated chimney lamp with thick echinoid inward slanting flat rim, surrounded by a thin fillet, and protruding central tube. Part of rim and bowl with nozzle missing. Beige orange clay, paler outside (self-slipping), purplish at core, finely micaceous, shimmering. Lustrous diluted brown glaze inside bowl (bottom only) and on funnel as well as a thin fillet around inner part of rim. Traces of soot around nozzle.

From : NW Sector, occupation layer (sic!).

Parallels : GALLI 2004, pl. 3 nr. 41, 43 (type 5c, ca. 575-525).

B. 72-116 [Fig. 5 ; Pl. 11]

Ber. 72-181

D. max. 9. 0 ; D. rim 9. 0 ; H. body 2. 7 ;

Carinated chimney lamp with thick echinoid inward slanting flat rim, surrounded by a thin fillet. Section of rim and bowl with start of central tube, completely furred up. Orange clay, finely micaceous, shimmering.

From : NW Sector, occupation layer (sic!).

Parallels : same type as B. 72-115.

B. 73-185 [Fig. 5 ; Pl. 11]

Ber. 73-173

D. max. 7. 9 ; D. rim 7. 6 ; pres. H. body 2. 0

Very sharply carinated lamp with broad flat projecting rim. Whole bottom and most part of nozzle missing. Orange beige clay, paler outside (self-slip), unmicaceous. Well finished and surfaced. Lustrous brown glaze on nozzle by askew dipping. Traces of soot around nozzle and nearby part of rim.

From : NW Sector, sq. 22, recess (pottery assemblage end of 7th / 1st half of 6th c. BC).

Parallels : FURTWÄNGLER 1989, 131-133 IIIc/9, 132 fig. 27 (« Entwickelte samische Form der 2. Hälfte des 6. Jhs. V. Chr. », ca. 545-535).

B. 74-84 [Fig. 5 ; Pl. 12]

Ber. 74-74

D. max. 10. 0 ; D. rim 9. 2 ; H. body 2. 8 ; H. chimney 3. 0

Fragmentary thick-walled carinated lamp with protruding funnel and slightly projecting rim inward slanting and surrounded by a thin fillet. Greater part of rim and bowl with nozzle missing. Bright orange clay, purplish at core, finely micaceous, shimmering, with a few limestone grits.

From : NW Sector, semi-dugout VII (pottery assemblage mid-/ 3rd quarter 6th c. BC).

Parallels : FURTWÄNGLER 1989, 131 IIIc/8, 132 fig. 27, pl. 30 (ca. 545-535) ; KASSAB & SEZER 1995, 50 nr. 71 (« 4^e quart du VII^e s. Atelier éphésien ? »).

B. 84-91 [Fig. 5 ; Pl. 12]

Ber. 84-38

D. max. 9. 0 ; D. rim 8. 5 ; H. body 2. 15

Thick-walled low carinated lamp with thick flattened rim, slightly bulging outward. Whole bottom and more than half of walls and rim missing. Purplish orange clay, purplish grey at core, paler outside. Mat brown glaze on nozzle by deep dipping overlapping rim. Traces of soot and burning at tip of nozzle and around inner rim.

From : NW Sector, sq. 669, pavement (pottery assemblage 2nd half of 6th / early 5th c. BC).

Parallels : GALLI 2004, pl. 4 nr. 54, 55 (type 5d, ca. 575-525).

B. 84-93 [Fig. 6 ; Pl. 12]

Ber. 84-128

D. max. 9. 5 ; D. rim 9. 0 ; H. body 2. 4 ; pres. H. funnel 1. 1

Thick-walled carinated chimney lamp with echinoid projecting rim, concave on top and slanting inward. Most part of rim and bowl with nozzle missing. Bright orange beige clay, purplish at core, light buff outside (self-slip), lustrous surfaced. Lustrous brown glaze inside bowl and fillet around inner edge of rim.

From : NW Sector, Pit 31 (1st half / 3rd quarter 6th c. BC).

Parallels : HOWLAND 1958, pl. 3 nr. 71-72 (type 12A, 2nd and 3rd quarters of 6th cent.); GALLI 2004, pl. 3 nr. 43 (type 5c, ca. 575-525).

B. 84-96 [Fig. 6 ; Pl. 12]

Ber. 84-323

D. max. 8. 5 ; D. rim 7. 7 ; H. body 2. 1 ; pres. H. funnel 1. 6

Thick-walled carinated chimney lamp with echinoid projecting rim, slightly concave on top and slanting inward. Half of bowl and rim with nozzle missing. Orange beige clay, purplish grey at core, paler outside (self-slip), finely micaceous, slightly shimmering (scattered mica flakes). Brush-painted lustrous black glaze inside bowl, fillet around inner edge of rim ; nozzle by dipping. More carefully finished than B. 84-93.

From : NW Sector, Pit 29 (1st half / 3rd quarter 6th c. BC).

Parallels : same type as B. 84-93.

B. 89-98 [Fig. 6 ; Pl. 12]

Ber. 89-41

D. max. 8. 5 ; D. rim 7. 9 ; H. body 2. 25 ; H. funnel 2. 25

Heavy carinated chimney lamp with, low funnel, overhanging flattened rim, slanting inward and surrounded by a thin listel on either side. Nearly complete, except end of nozzle broken askew. Bright orange clay, orange buff outside, very micaceous, shimmering. Lustrous brown glaze on inner bowl and on nozzle by dipping. Traces of soot around nozzle and nearby part of rim.

From : NW Sector, Roman building.

Parallels : GALLI 2004, pl. 3 nr. 41 (type 5c, ca. 575-525), pl. 8 nr. 121.

B. 89-99 [Fig. 6 ; Pl. 12]

Ber. 89-42

D. max. 8. 05 ; D. rim 8. 05 ; H. body 1. 7 ; H. funnel 1. 8

Heavy carinated chimney lamp with low funnel, overhanging flattened rim, slanting inward and surrounded by a thin fillet. Nearly complete ; end of nozzle broken. Orange beige clay, light buff outside, very micaceous (small flakes), shimmering. Lustrous dark brown glaze : bottom of bowl and fillet around inner edge of rim, as well as nozzle by dipping.

From : NW Sector, Roman building.

Parallels : see B. 89-98.

Other carinated lamps: mesomphalos type

B. 63-154 [Fig. 7 ; Pl. 13]

Ber. 63-350 (?)

D. max. 12. 15 ; D. rim 11. 35 ; H. bowl 2. 3 ; H. central cone 1. 9

Big sharply carinated multi-nozzled lamp with concave shoulder, hollowed central cone and narrow inward slanting grooved rim sharply edged outside. Nearly half of bowl with one nozzle or more missing. Bright orange clay, paler superficially, finely micaceous. Brick red mat glaze on flat of rim, nozzles and central cone. Traces of soot around the two remaining nozzles. « Samian » type, variant ?

From : Sector Γ, well (pottery assemblage 1st half 6th c. BC).

Parallels : BELOV 1972, 21, 23 fig. 10.

B. 70-204 [Fig. 7 ; Pl. 13]

Ber. 70-198

D. rim 8. 3 ; D. bowl 7. 9 ; H. body 2.7 ; H. central cone 1. 7

Thin-walled sharply carinated lamp with broad concave projecting rim, inward slanting and sharply edged outside, and low central cone. One quarter or so of bowl and rim with nozzle missing. Pale orange clay, purplish at core, dark orange underneath, sparingly micaceous, with lime particles. Possible traces of soot on rim nearby nozzle attachment.

From : Sector Γ, occupation layer (sic!).

Parallels : *Tocra* I, fig. 68 nr. 1436 (L. 8, ca. 590-565); GALLI 2004 pl. 3 nr. 44 (type 5c, ca. 575-525).

B. 71-117 [Fig. 7 ; Pl. 13]

Bep.71-44

D. max. 9. 1 ; D. rim 9. 0 ; H. body 2. 5 ; H. central cone 3. 0

Big carinated lamp with broad rim and highly protruding hollowed central cone. Greater part of rim and flanges missing, as well as tip of nozzle. Dark orange clay, greyish at core, very micaceous, shimmering. Creamy slip. Dark brown glaze : inside bowl and on central cone, with fillet around inner edge of rim ; on nozzle, by deep dipping overlapping on nearby part of rim.

From : NW Sector, occupation layer (sic!).

Parallels : KASSAB & SEZER 1995, 58 nr. 98 (2nd. half of 6th cent. BC, Ephesian workshop); GALLI 2004, pl. 3 nr. 46, 51 (type 5c, ca. 575-525).

B. 71-121 [Fig. 7 ; Pl. 13]

Ber. 71-317

D. max. 9. 0 ; D. rim 8. 0 ; H. body 2. 6

Big carinated lamp with broad rim (surrounded by thin fillet), seemingly with central cone. Most part of bowl and rim missing ; nozzle preserved. Same type of rim as B. 71-117, but with surrounding fillet and more slanting inward. Dark orange clay, paler outside, very micaceous, shimmering. Lustrous surfaced, but mostly black-smoked by accidental fire (burnt layer ?) rather than normal use (no traces of soot around nozzle). Shiny dark brown glaze inside bowl and on nozzle by dipping.

From : NW Sector, Well 9 (pottery assemblage 1st half / mid 6th c. BC).

Parallels : FURTWÄNGLER 1989, 131 IIIc/8, 132 fig. 27, pl. 30 (ca. 545-535) ; KASSAB & SEZER 1995, 58 nr. 99 (2nd half of 6th cent. BC, Ephesian workshop).

B. 71-256 [Fig. 8 ; Pl. 13]

Ber. 71-71

D. max. 9. 6 ; D. rim 9. 2 ; H. body 2. 85

Carinated chimney (?) lamp with convex shoulder and inward slanting projecting rim. Central part of bowl missing, the start of the funnel / broad cone attachment remaining visible. Orange clay, greyish beige at core, finely micaceous, shimmering. Lustrous brown glaze on nozzle and adjoining part of rim.

From : NW Sector, occupation layer (sic!).

Parallels : GALLI 2004, pl. 3 nr. 36 (type 5b, ca. 600-550).

B. 72-111 [Fig. 8 ; Pl. 14]

Ber. 72-73

D. max. 10. 0 ; D. rim 9. 0 ; H. body 2. 45

Carinated lamp with thick echinoid inward slanting flat rim, surrounded by a thin fillet. Section of rim and wall, supposedly of chimney type. Orange clay, darker at core, paler outside, finely micaceous, shimmering.

From : NW Sector, Pit 18 (pottery assemblage 1st half - 3rd quarter 6th c. BC).

Parallels : very probably same type as B. 72-115 (supra p. 26).

B. 72-113 [Fig. 8 ; Pl. 14]

Ber. 72-90

D. max. 10. 0 ; D. rim 8. 9 ; D. base 7. 0 ; H. body 2. 35 ; H. central cone 3. 35

Big carinated lamp with squat body, broad projecting rim and protruding central cone. Half of body and rim missing. Beige orange clay, darker at core, finely micaceous, shimmering. Lustrous surface. Brush painted dark brown glaze on rim, bowl and central cone, on nozzle too by dipping.

From : NW Sector, occupation layer (sic!).

Parallels : GALLI 2004, pl. 3 nr. 51 (type 5c, ca. 575-525).

B. 73-202 [Fig. 8 ; Pl. 14]

Ber. 73-145

D. bowl 7. 6 ; D. rim 8. 25 ; D. raised base 5. 25 ; H. body 2. 8 ; H. central cone 2. 9

Wide-carinated lamp with nearly upright shoulder and broad flat overhanging rim, high central cone and raised base. Part of bowl and rim with nozzle missing. Light beige clay, purplish at core, greyish beige outside, unmicaceous. Diluted creamy slip on flat part of rim, mostly washed out. Shiny black glaze : on central cone, discus surrounded by fillet ; on flat part of rim, central band between two pairs of concentric fillets. Corinthian ?

From : NW Sector, sq. 31, Pits 21-23, recess (pottery assemblage 2nd quarter - mid-6th c. BC).

Parallels : BOITANI 1971, 266 fig. 82 nr. 769 (type d, ca. 580/570-530/520).

B. 75-138 [Fig. 9 ; Pls. 3b & 14]

Ber. 75-207

D. max. 8. 65 ; D. rim 8. 5 ; H. body 2. 75 ; H. central cone 2. 9

Sharply carinated lamp with broad bevelled sharply everted rim (diabolo profile), highly protruding hollowed central cone and prominent nozzle. One small section of rim, bowl and nozzle missing. Orange clay, purplish at core, paler outside, well surfaced. Lustrous dark brown glaze on nozzle by deep dipping up to inner part of adjoining rim. Traces of soot and burning on nozzle, rim and central cone.

From : NW Sector, semi-dugout, sq. 9, rectangular rocky bed (pottery assemblage 2nd / 3rd quarter 6th c. BC).

Parallels : type represented at Histria by at least two fragmentary pieces : one from the Lambrino excavations 1927-1942 and one from Tariverde, rural site of the Histrian chora (both unpublished).

B. 76-124 [Fig. 9 ; Pl. 14]

Ber. 76-200

D. max. (rim) 8. 3 ; D. bowl 7. 5 ; H. body 2. 3 ; H. central cone 1. 9

Sharply carinated lamp with concave shoulder (diabolo profile), sharp-profiled central cone and very broad overhanging flattened rim, sharp edged and slightly slanting inward. Nearly complete except most part of nozzle and some

chips of rim. Purplish orange clay, paler outside, finely micaceous. Brown glaze on nozzle and adjacent part of rim by deep dipping. Traces of soot around nozzle. North-Ionian ?

From : NW Sector, occupation layer (sic!).

Parallels : see B. 75-138.

B. 77-210 [Fig. 9 ; Pls. 2d & 15]

Ber. 77-106

D. max. 6. 85 ; D. rim 6. 6 ; H. bowl 2. 35 ; H. central cone 2. 6

Small carinated lamp with slightly splaying rim and thick protruding hollowed central cone. Nearly complete except a little chip of nozzle. Orange beige clay, purplish at core, paler outside, finely micaceous, with small dark inclusions. Traces of soot on tip of nozzle.

From : NW Sector, occupation layer (sic!).

Parallels : GALLI 2004, pl. 3 nr. 50 (type 5b, ca. 600-550).

B. 82-75 [Fig. 9 ; Pl. 15]

Ber. 82-260

D. max. 10. 0 ; D. rim 8. 5 ; H. 2. 5

Fgt. of carinated lamp with narrow flattened rim, slightly bulging outward. Orange beige clay, greyish at core, finely micaceous and shimmering, with light beige self-slip. Traces of soot around nozzle.

From : NW Sector, semi-dugout 24 (pottery assemblage beginning 6th c. BC).

Parallels : GALLI 2004, pl. 3 nr. 40 (type 5b, ca. 600-550).

B. 89-102 [Fig. 10 ; Pls. 3a & 15]

Ber. 89-158

D. max. 9. 5 ; D. rim 8.55 ; H. body 2. 45 ; H. central cone 3. 5

Sharply carinated lamp with concave projecting rim, inward slanting and surrounded by a thin fillet, and highly protruding hollowed central cone. Large part of bowl and rim with nozzle missing. Purplish beige clay, light buff outside, purplish red at core, unmicaceous. Lustrous black glaze, mostly weathered or flaking off, covering the entire bowl, central cone and inner edge of rim.

From : NW Sector, semi-dugout 49 (pottery assemblage 2nd quarter 6th c. BC).

Parallels : GALLI 2004, pl. 3 nr. 51 (type 5c, ca. 575-525).

B. 385 [Fig. 10 ; Pls. 3c & 15]

Berezan' 127 / Iv

D. max 8. 0 ; D. rim 8. 3 ; H. bowl 2. 4 ; H. cone 1. 4 ; L. with nozzle 10. 9

Sharply carinated lamp with low central cone, broad projecting sharp edged rim slanting inward and big sloping nozzle . Only two chips of rim are missing. Traces of soot around nozzle. Fine orange beige / greyish beige clay, purplish at core, unmicaceous. Brown glaze on nozzle and next part of rim (dipping). On top of rim, two incised letters : Δ and ligature ΗΔ.

From : context unspecified (v. Stern excavations ?).

Parallels : *Tocra* I, 141 fig. 68 nr. 1434 ; BOITANI 1971, 266 fig. 82 nr. 2194 (type d, ca. 580 / 570-530 / 520). A similar shape from Histria has revealed a

North-Ionian chemical pattern (Erythrae ?).

Multicarinated lamp of North-Ionian / Aeolian type

B. 89-100 [Fig. 10 ; Pl. 15]

Ber. 89-127

D. max. 8. 9 ; D. base 4. 8 ; H. body 2. 7 ; D. mouth 4. 2

Carinated biconical lamp with constricted opening, surrounded by a thin fillet, sloping nozzle rising up from the shoulder and raised flat base. One half of body missing ; most part of nozzle broken. Purplish beige clay, purplish orange at core, finely micaceous, with fine limestone particles and some bigger-sized ones. Diluted brown glaze : fillet around rim, another one at mid-shoulder and band round maximum diameter. Traces of soot on rear nozzle. North Ionian / Aeolian type (simple carinated variant with flat bottom).

From : NW Sector, sq. 712, recess (pottery assemblage not later than 1st quarter 6th c. BC).

Parallels : AKURGAL 1983, pl. D (um 600 v. Chr.) & E1 (ende des 7. Jhs. v. Chr.) ; ERSÖY 1993, vol. text p. 421-422 type I; pl. 75 nrs. 641-642 (Clazomenae, end 7th -1st quarter 6th c. BC) ; UTILLI 1999, 124 Abb. X (Assos, ca. 600-580 BC). One quite similar piece is exhibited in the Ephesus museum.

Other carinated lamps: flat bottomed types

B. 76-108 [Fig. 10 ; Pl. 16]

Ber. 76-45

D. max. (rim) 7. 5 ; D. bowl 7. 3 ; H. body 2. 3 ; H. bulge 0. 7

Carinated lamp with broad inward slanting projecting rim, grooved around, and bulging bottom (or gentle start of central cone ?). Large section of rim and bowl missing. Dark orange beige clay, still darker at core, brown surfaced (overfired), with scattered mica flakes. No glaze. Traces of soot around nozzle and inside wick-hole.

From : NW Sector, sq. 141, semi-dugout 18 (pottery assemblage mid 6th c. BC).

Parallels : GALLI 2004, pl. 3 nr. 40 (type 5b, ca. 600-550).

B. 82-162 [Fig. 10 ; Pl. 16]

Ber. 82-90

D. max. 7. 2 ; D. rim 6. 0 ; D. ring base 3. 0 ; H. body 2. 3

Small sharply carinated thin-walled lamp with concave shoulder, blunt rim, raised nozzle, flat bottom and low ring base. More than one half of bowl and rim missing. Orange beige clay, paler outside, light grey at core, sparingly micaceous. Diluted brown glaze on nozzle by dipping. Slight traces of soot at the very end of nozzle.

Context : reportedly found with fgts. of Ionian cups of Villard B1 (of Alexandrescu 's « Lambrino » variant) and B2, North-Ionian askos and Laconian krater.

From : NW sector, House 1, room B (pottery assemblage end 6th – beginning 5th c. BC).

Parallels : ZHURAVLEV *et al.* 2007, p. 69 nr. 97 (unlocated centre, 5th cent. BC ?).

B. 87-99 ; Pl.16]

Ber. 87-75

D. max. 10. 4 ; D. rim 10. 0 ; pres. H. 3.5

Big carinated lamp with thick projecting rim slanting inward and strong rounded nozzle. Orange beige clay, grey at core, with purple inclusions. Lustrous medium grey coating covering whole surface. Careless finishing. Traces of soot around wick hole.

From : context unspecified.

Parallels : HOWLAND 1958, 71-72 (type 12A, 2nd - 3rd quarters of 6th cent. BC) ; FURTWÄNGLER 1989, 135 IV/6, 134 fig. 28, pl. 31 (ca 520/510).

Chimney lamps with rounded body and incurved rim

B. 69-183 [Fig. 11 ; Pl. 17]

Ber. 69-233

D. max 11. 1 ; H body / chimney 3. 0 ; H. nozzle 3. 5

Big black-glazed chimney lamp with incurved rim. Slanting up nozzle. Fine pinkish beige clay, paler at core. Lustrous black glaze around upper body and nozzle and inside the bowl.

From : Sector Γ, well 2 (pottery assemblage 1st half to mid- 6th c. BC).

Parallels : BAILEY 1975, 32 nr. Q 25, pl. 9 (Attic, Howland type 22A, ca. 500-460 BC).

B. 73-320 [Fig. 11 ; Pl. 18]

Ber. 73-233

D. max. 10. 4 ; H. body 3. 0 ; H. funnel 3. 2

Big chimney (or, possibly too, vertical hang handled ?) lamp with rounded body, incurved rim and pointed nozzle with narrow wick hole. Nearly complete, except funnel broken. Dark orange beige clay, greyish at core, spangled of mica flakes. Dark brown / blackish mat glaze : inside bowl, double band on top of rim and shoulder, and a touch across base of nozzle. Inside the bowl, two circular dark fillets (with traces of white paint): one on the bottom and another one around the funnel halfway up. Upper part of rim strongly smoke-blackened.

From : NW Sector, Pit 25 (pottery assemblage 2nd half 6th / beginning 5th c. BC).

Parallels : BAILEY 1975, pl. 9 Q 25 (Attic, ca. 500-460).

B. 76-106 [Fig. 11; Pl. 18]

Ber. 76-39

D. max. 9. 6 ; H. body 2.4 ; H. funnel 1. 85 ; D. funnel 1. 2

Thin-walled chimney lamp with rounded body, slender funnel and rolled rim, presumably two-nozzled. Large section of rim and outer wall missing (with second nozzle ?). Orange clay, paler outside, finely micaceous. Brown glaze, somewhat iridescent, on nozzle by deep dipping, overlapping rim. Attic ?

From : NW Sector, occupation layer (sic!).

Parallels : HOWLAND 1958, pl. 7 nr. 194 (type 22A, ca. 500-480); ZHURAVLEV *et al.* 2007, 65 nr. 90 (Attic, 1st half of 5th cent. BC), 68 nr. 96.

B. 77-77 [Fig. 11 ; Pl. 17]

Ber. 77-135

D. max. 9. 15 ; H. body 2. 25 ; H. funnel 2. 4

Squat black-glazed chimney lamp with rounded body and incurved rim. One part of rim and bowl with nozzle missing, as well as a small fragment on the opposite side. Beige orange clay, paler outside (self-slip), finely micaceous. Dark brown glaze inside bowl and, seemingly, nozzle by dipping. Traces of soot around the nozzle attachment.

From : NW Sector, sq. 21, recess (pottery assemblage mid-6th c. BC).

Parallels : *Tocra* II 1973, fig. 28 nr. 2272 ; GALLI 2004, pl. 5 nr. 77-78 (type 7a, ca. 550-500).

B. 86-50 [Fig. 11 ; Pl. 18]

Ber. 86-241

D. max. 10. 1 ; H. body 2. 2

Two-nozzled chimney (?) lamp with rounded body, slightly incurved rim and semicircular nozzle. Central part of bottom and half of rim with most part of second nozzle missing. Orange beige clay, finely micaceous, shimmering. Lustrous dark brown glaze : both nozzles by dipping extended to nearby segments of rim.

From : NW Sector, occupation layer (sic!).

Parallels : BOITANI 1971, fig. 89 nr. 876 (type e4, ca. 550-500/490); GALLI 2004, pl. 5 nr. 75 (type 7a, ca. 550-500).

B. 91-79 ; [Pls. 4c & 18]

Ber. 91-237

D. max. 9. 6 ; H. body 2. 5 ; H. funnel 3. 2

Chimney lamp with rounded body, incurved rim and protruding slanting funnel. Large part of bowl and rim with nozzle missing ; funnel partly broken askew. Purplish orange clay, purplish grey at core, light buff outside (self-slip). Brush-painted dark brown glaze on : whole bottom of bowl and funnel ; narrow band around inner rim ; nozzle by dipping. Neglected finishing.

From : NW Sector, semi-dugout 71 (pottery assemblage mid-6th c. BC).

Parallels : *Tocra* I (1966), fig. 68 nr. 1428 ; *Tocra* II (1973), fig. 26 nr. 2272 ; GALLI 2004, pl. 5 nr. 75 (type 5a, ca. 600-550).

Lamps with rounded body, incurved rim and central cone or bulge

B. 69-121 [Fig. 12 ; Pl. 19]

Ber. 69-152

D. max. 7. 4 ; H. body 2. 1 ; H. central cone 1. 6

Thin-walled lamp with echinoid body, hollowed central cone and rolled rim. Nearly $\frac{3}{4}$ of outer bowl and rim with nozzle (and possible handle ?) missing. Orange beige clay, purplish at core, paler outside, finely micaceous. Brush-

painted lustrous dark brown glaze : central cone and concentric fillet and band ; double band with intercalary fillet on top of rim. Under the bowl, red dipinto after firing AV.

From : Sector Γ, sq. 191, recess within virgin soil.

Parallels : *Tocra* I, fig. 68 nr. 1429 (D. III L.7, ca. 565-520/510).

B. 73-201 [Fig. 12 ; Pl. 19]

Ber. 73-144

D. max. 9. 8 ; H. body 2. 3

Thick-walled lamp with rounded body, rolled rim, slightly flattened on top, and low central cone. More than one half of bowl and rim with nozzle missing. Bright orange clay, purplish at core, unmicaceous. Yellowish diluted slip (obvious inside bowl). Lustrous dark brown glaze : medallion surrounded by fillet on central cone ; triple fillet of decreasing thickness on inner rim.

From : NW Sector, Pits 21-23, recess, sq. 31 (pottery assemblage 2nd quarter - mid-6th c. BC).

Parallels : GALLI 2004, pl. 5 nr. 76 (type 7a, ca. 550-500).

B. 74-96 [Fig. 12 ; Pl. 19]

Ber. 74-185

D. max. 8. 0 ; H. body 2. 3 ; H. central cone 1. 0

Thin-walled lamp with rounded body, central cone, rolled rim and horizontal handle. Two thirds of the bowl and rim together with nozzle missing. Greyish buff clay, purplish at core, spangled with mica flakes, shimmering. Lustrous dark brown glaze on central cone with surrounding fillet and broad band around inner part of rim and upper handle.

From : NW Sector, occupation layer (sic!).

Parallels : GALLI 2004, pl. 5 nr. 76 (type 7a, ca. 550-500).

B. 76-120 [Fig. 12 ; Pls. 4a & 19]

Ber. 76-151

D. max. 7. 8 ; total L. with nozzle and handle 12. 2 ; H. body 2. 4 ; H. central cone 2. 2

Lamp with rounded body, incurved rim, low central cone and raising horizontal handle opposite nozzle. Complete. Pale orangebeige clay, lighter outside (self-slip). Mat dark brown glaze inside whole bowl, two thick fillets around top of rim and both nozzle and handle by deep askew dipping. Fine fabric.

From : NW Sector, sq. 111, Pit 39 (pottery assemblage 2nd-3rd quarters 6th c. BC).

Parallels : GALLI 2004, pl. 5 nr. 81 (type 7b, ca. 500-460).

B. 84-95 [Fig. 12 ; Pl. 19]

Ber. 84-309

D. max. 7. 8 ; pres. L. with nozzle 10. 9 ; H. body 2. 1 ; H. central cone 0. 7

Lamp with rounded body, rolled rim, central cone and raising horizontal handle opposite nozzle. Handle broken. Fine orange beige clay, tiny bit

micaceous. Shiny dark brown glaze : on rim, double band, with thin fillet in-between ; all around nozzle ; around handle attachments (or handles by dipping ?) ; central cone, surrounded with circular stripe. Traces of soot on nozzle and inside wick hole. Fine fabric.

From : NW Sector, space K (pottery assemblage 3rd quarter 6th c. BC).

Parallels : same type as B. 76-120, but with lower central cone. GALLI 2004, pl. 5 nr. 76 (type 7a, ca. 550-500).

B. 74-232 [Fig. 13 ; Pl. 20]

Ber. 74-142

D. max. 9. 4 ; H. body 2. 25 ; H. central cone 0. 45

Lamp with rounded body, rolled rim, very low central cone and horizontal handle opposite nozzle. Complete, except handle broken and minor chips. Bright orange clay, purplish at core, paler outside, finely micaceous, shimmering, with fine dark inclusions and lime particles. No remains of glaze.

From : NW Sector, occupation layer (sic!).

Parallels : ZHURAVLEV *et al.* 2007, 47 nr. 42 (2nd half of 6th cent.).

B. 76-138 [Fig. 13 ; Pl. 20]

Ber. 76-353

D. max. 10. 0 ; H. body 2. 5

Thick-walled lamp with incurved rim, slightly flattened, slanting inward, presumably with central cone. Most part of bowl and rim missing. Bright orange clay, paler outside, sparingly micaceous. Traces of paleorange slip around rim and nozzle with some dripping inside bowl. Traces of soot and burning around nozzle and inner rim.

From : NW Sector, sq. 45, Pit 44 (no datable assemblage except some fgts. of intrusive Roman amphoras).

Parallels : HOWLAND 1958, pl. 3, 31 nr. 76 (type 12B, end of 6th cent.); GALLI 2004, pl. 6 nr. 84, 88 (type 8a, ca. 525-480).

B. 77-76 [Fig. 13 ; Pl. 20]

Ber. 77-131

D. max. 8. 4 ; H. body 2. 25; H. central cone 1. 75

Lamp with rounded body, thick bottom, rolled rim and « nipped » central cone. Large part of bowl and rim with nozzle missing. Bright orange clay, orange beige outside. Shiny dark brown glaze : double fillet around rim and on top of it, on central cone (surrounded by circular white fillet, mostly worn away).

From : NW Sector, occupation layer (sic!).

Parallels : ZHURAVLEV *et al.* 2007, 112 nr. 194 (end of 6th - 1st half of 5th cent. BC).

B. 79-57 [Fig. 13 ; Pl. 20]

Ber. 79-20

D. max. 7. 4 ; H. body 2. 1 ; H. central cone 0. 8

Lamp with echinoid body, rolled rim, low central cone and horizontal handle opposite the nozzle. One small part of bowl and rim missing ; handle broken.

Purplish orange clay, purplish grey at core, finely micaceous with scattered mica flakes, hard fired. Brush-painted lustrous black glaze : discus around central cone, surrounded by double white fillet ; simple band on either side of rim ; handle attachments ; nozzle by dipping. Traces of soot around nozzle. Found together with « Lydian » bowl.

From : NW Sector, sq. 58, semi-dugout 13 (pottery assemblage 2nd half 6th – beginning 5th c. BC).

Parallels : GALLI 2004, pl. 5 nr. 76 (type 7a, ca. 550-500).

B. 79-155 [Fig. 13 ; Pl. 20]

Ber. 79-79

D. max. 8. 2 ; H. body 2. 1 ; H. central cone 1. 9

Lamp with echinoid body, flattened rolled rim and central cone. Complete except nozzle broken. Bright orange clay, purplish at core, finely micaceous, with fine garnet-red inclusions and lime grits, plus one dark grey gravel (D. 0. 2). Weathered surface. Careless finishing. Traces of soot around base of nozzle.

From : NW Sector, sq. 72, occupation layer (sic!).

Parallels : GALLI 2004, pl. 5 nr. 81 (type 7b, ca. 500-460).

Lamps with rounded or echinoid body, raised base, inwards folded flat rim and central cone or bulge

B. 62-51 [Fig. 14 ; Pl.21]

Ber. 62-63

D. max. 7. 7 ; D. raised base 5. 7 ; H. body 2. 3 ; H. central cone 1. 8

Squat lamp with rounded body, inward folded flat rim, hollowed central cone, raised base and steep raising horizontal handle opposite nozzle. One third of bowl and rim with most part of nozzle and handle missing. Orange clay, brighter at core, paler outside, sparingly micaceous. Brown glaze, turned to lustrous dark brown in places : bowl and central cone, 9 concentric fillets on rim, nozzle by dipping.

From : E Sector, humus.

Parallels : *Tocra I*, fig. 68 nr. 1430 (D. III L. 7, ca. 565-520-510) ; SHEIKO 2016, p. 82 fig. 2 : 5.

B. 69-237 [Fig. 14 ; Pl.21]

Ber. 69-80

D. max. 7. 4 ; D. raised base 5. 35 ; H. body 2. 2 ; H central cone 1. 4

Squat lamp with rounded body on raised base, incurved rim and central cone. Large part of bowl wall and nozzle missing. Orange beige clay, purplish grey at core, pale orange underneath, greyish beige outside. No remains of glaze. Traces of soot around edge of rim. Attic ?

From : Sector Γ, occupation layer (sic!).

Parallels : *Tocra I*, fig. 68 nr. 1430 (D. III L. 7, ca. 565-520/510).

B. 70-124 [Fig. 14 ; Pl.21]

Ber. 70-278

D. max. 9. 0 ; D. raised base 5. 6 ; H. body 1. 65

Low lamp with rolled rim, raised base and slightly bulging bottom / low cone. Large part of outerbowl and rim missing, as well as most part of nozzle (presumably small and pointed). Bright orange clay, finely micaceous, light beige outside. Lustrous surfaced. Shiny dark brown glaze, lighter in places : brush-painted inside bowl, fillet around inner rim and band outside around shoulder, tip of nozzle by dipping. Attic.

From : W Sector, Pit 1.

Parallels : HOWLAND 1958, pl. 6 nr. 164-70 (type 21B, ca. 480-415).

B. 73-200 [Fig. 14 ; Pl.21]

Ber. 73-52

D. max. 7. 6 ; D. raised base 5. 75 ; H. body 2. 5 ; H. central cone 2. 3

Lamp with rounded body, incurved rim, raised base and horizontal handle opposite nozzle. Nearly complete except nozzle and handle broken. Orange clay, orange beige outside. Lustrous surfaced base. Shiny dark brown glaze : on central cone, 6 concentric fillets on rim, nozzle and handle attachments. Remains of soot on either side of nozzle and on half section of rim. Attic ?

From : NW Sector, sq. 24, recess (pottery assemblage 2nd-3rd quarters 6th c. BC).

Parallels : *Tocra I*, fig. 68 nr. 1430 (D. III, L. 7, ca. 565-520 ; SHEIKO 2016, p. 82 fig. 2 : 5.

B. 89-103 [Fig. 14 ; Pl.21]

Ber. 89-290

D. max. 8. 5 ; D. raised base 5. 45 ; H. body 2. 6 ; H. central cone 2. 0

Lamp with rounded body, rolled rim, hollowed central cone, raised base and raising horizontal handle opposite the nozzle. Handle broken. Orange beige / light buff clay, light grey at core, sparingly micaceous. Glossy dark brown glaze on central cone, inner edge of rim, nozzle and around handle attachments. Traces of soot around nozzle.

From : NW Sector, occupation layer (sic!).

Parallels : *Tocra I*, 141 fig. 68 nr. 1430 (D. III, L. 7 = 565-520/510) ; SHEIKO 2016, p. 82 fig. 2 : 5.

Lamps with incurved rim and flat bottom or bulge

B. 69-120 [Fig. 15 ; Pl.22]

Ber. 69-151

D. max. 8. 2 ; D. base 5. 6 ; H. body 2. 0

Low lamp with rolled rim, pointed nozzle and thick flat bottom. Half of bowl and rim missing. Dark beige clay, finely micaceous. Brown glaze around nozzle and nearby rim by dipping. Traces of soot around nozzle. Careless finishing.

From : Sector Γ, recess in virgin soil.

Parallels : GALLI 2004, pl. 8 nr. 119

B. 75-135 [Fig. 15 ; Pl.22]

Ber. 75-131

D. max. 9. 0 ; pres. H. 2. 2

Very fragmentary lamp with rounded body, rolled rim and pointed nozzle. Most part of bowl and rim missing. Fine orange beige clay. Dark brown lustrous glaze on nozzle by dipping, overlapping on rim.

From : NW Sector, occupation layer (sic!).

Parallels : see B. 69-120

B. 75-139 [Fig. 15 ; Pl.22]

Ber. 75-217

D. max. 7. 9 ; L. with nozzle 9. 15 ; H. bowl 2. 0

Small lamp with echinoid body, incurved rim, slightly flattened, flat bottom, slightly concave base and small pointed nozzle. Complete. Orange buff clay, paler outside, finely micaceous. Diluted mat brown glaze on nozzle and adjacent part of rim by dipping. Traces of soot around nozzle.

From : NW Sector, occupation layer (sic!).

Parallels : GALLI 2004, pl. 7 nr. 113 (type 10c, ca. 500-460).

B. 77-68 [Fig. 15 ; Pl.22]

Ber. 77-169

D. max. 8. 7 ; H. body 1. 7

Fragmentary lamp with inward folded flattened rim and slightly bulging centre. Half of bowl and rim missing ; nozzle mostly broken. Pale beige clay, mat yellowish cream outside (self-slip). Traces of soot around nozzle. Local manufacture ?

From : NW Sector, sq. 20, occupation layer (sic!).

Parallels : GALLI 2004, pl. 7 nr. 111 (type 10b, last years of 6th-480).

B. 82-185 ; Pl.22]

Ber. 82-9

D. max 9. 0 ; D. raised base 7. 2 ; H. body 2. 4

Fgt. of lamp with rounded body, incurved rim, flat bottom and raised flat base. Most part of bowl and rim as well as nozzle missing. Fine orange clay mostly reduced by accidental fire (even in section). Originally black glazed ? Attic ?

From : NW Sector, well (pottery assemblage 2nd half 6th / beginning 5th c. BC).

Parallels : see B. 69-120.

B. 87-37 [Fig. 15 ; Pl.22]

Ber. 87-122

D. max. 8. 8 ; D. base 6. 4 ; H. body 1. 8

Low lamp with rolled rim, flat base, slightly bulging bottom and pointed nozzle. Large part of bowl and rim missing. Orange clay, light grey at core, finely micaceous, with lime inclusions. No touch of glaze. Careless finishing. Traces of soot around nozzle.

From : NW Sector, Pit 51 (pottery assemblage undatable except 26% of Roman period).

Parallels : see B. 69-120.

Small lamps with incurved rim and central cone

B. 71-118 [Fig. 16 ; Pl.23]

Ber. 71-61

D. max. 8. 0 ; H. body 1. 9 ; H. central cone 1. 3

Small lamp with incurved rim, slightly flattened, and low central cone. Complete. Orange beige clay underside, light buff outside (self-slip), Bright orange at core, finely micaceous, lustrous surfaced all around. Shiny reddish brown glaze Inside bowl and two concentric fillets around edge and on top of rim ; on nozzle by dipping. Traces of soot around nozzle and nearby part of rim.

From : NW Sector, Pit 1 (pottery assemblage 2nd half 6th c. BC).

Parallels : KASSAB & SEZER 1995, 63 nr. 114 (Lindos, end of 6th or beginning 5th, Rhodian workshop) ; ZHURAVLEV *et al.* 2007, p. 44 nr. 32 (Porthmion, end of 6th-1st half 5th c. BC; SHEIKO 2016, p. 81 fig. 2 : 6.

B. 72-110 [Fig. 16 ; Pl.23]

Ber. 72-10

D. max. 7. 75 ; H. body 1. 9 ; H. central cone 1. 25

Small lamp with rounded body, incurved rim and hollowed central cone. Section of bowl and rim with nozzle missing. Dark orange beige clay, dark beige outside, finely micaceous with numerous mica flakes, shimmering. Remains of mat black glaze on nozzle by deep dipping overlapping rim. Traces of soot and burning around inner edge of rim.

From : NW Sector, occupation layer (sic!).

Parallels : GALLI 2004, pl. 5 nr. 76 (type 7a, ca 550-500) ; SHEIKO 2016 p. 81 fig. 2 : 6.

B. 76-140 [Fig. 16 ; [Pls. 4^e & 23]

Ber. 76-381

D. max. 7. 6 ; H. body 2. 0 ; H. central cone 1. 5

Small lamp with echinoid body, rolled rim, low central cone and raising pointed nozzle. Complete. Dark orange beige clay to greish buff, spangled with golden mica, very shimmering (big mica flakes). Lustrous dark brown on nozzle and nearby part of rim by deep dipping. Indifferent serial finishing. Traces of soot around wick hole.

From : W Sector, occupation layer (sic!).

Parallels : BOITANI 1971, 270 fig. 84, 282 fig. 89 nr. 244 (type e4, ca. 550-500/490) BOITANI = GALLI 2004, pl. 5 nr. 76 (type 7a, ca. 550-500).

B. 84-92 [Fig. 16 ; Pl.23]

Ber. 84-99

D. max. 7. 5 ; D. base 6. 7 ; H. body 2. 1 ; H. central cone 1. 7

Fragmentary small lamp with rounded body, rolled rim and low central cone. Large section of rim and walls missing. Orange beige clay, purplish at core, paler outside (self-slip), finely micaceous, shimmering (spangled with small mica

flakes). Lustrous brown glaze on nozzle by deep dipping overlapping rim. Simple fabric.

From : NW Sector, semi-dugout 29 (pottery assemblage 2nd half 6th / 1st quarter 5th c. BC).

Parallels : GALLI 2004, pl. 5 nr 76 (type 7a, ca. 550-500).

B. 84-94 [Fig. 16; Pl.23]

Ber. 84-217

D. max. 7. 6 ; D. base 7. 0 ; H. body 1. 8 ; H. central cone 1. 1

Small lamp with rounded body, rolled rim, low central cone and pointed nozzle. Complete. Bright orange beige clay, paler outside (self-slip), finely micaceous, shimmering. Lustrous dark brown glaze on nozzle by askew dipping overlapping rim. Traces of soot along inner rim opposite nozzle and on tip of central cone. Simple fabric.

From : NW Sector, Pit 23 (pottery assemblage 2nd half 6th (?) - 1st third 5th c. BC.).

Parallels : similar to B. 84-92 (same workshop ?).

Small lamps with echinoid body, low central cone and inwards sharply folded narrow concave rim

B. 63-152 [Fig. 17 ; Pl.24]

Ber. 63-248

D. max. 7. 4 ; H. body 2. 0

Small lamp with echinoid body, blunt central cone and inward sharply folded narrow concave rim. Large part of bowl and rim and most part of nozzle missing. Orange clay, brighter at core, paler outside, sparingly micaceous. Brush-painted dark brown glaze : discus surrounded by circular fillet on central cone, fillet on either side of rim. Traces of soot around nozzle.

From : N Sector, Pit.

Parallels : ZHURAVLEV *et al.* 2007, 44 nr. 32, 49-56 nr. 51-71 (Porthmion, c. 525-500/480) ; GALLI 2004, pl. 6 nr. 88, 93 (type 8a-b, c. 525-480).

B. 86-49 [Fig. 17 ; Pl.24]

Ber. 86-82

D. max. 7. 3 ; D. raised base 4. 4 ; H. body 2. 15

Small lamp with squat rounded body, inward folded concave rim, raised base and slightly bulging bottom. Nearly complete, except end of nozzle broken. Orange beige clay, very finely micaceous, shimmering. Dark brown glaze : narrow band alongside with fillet around inner rim, and nozzle by dipping.

From : NW Sector, occupation layer (sic!).

Parallels : GALLI 2004, pl. 6 nr. 93 (type 8b, ca. 525-480).

Small lamps with incurved rim and flat or slightly bulging bottom

B. 63-153 [Fig. 17 ; Pl.24]

Ber. 63-232

D. max. 6. 0 ; D. base 3. 7 ; H. body 2. 2

Coarse small lamp with convex body, incurved rim, flat base and slightly

bulging bottom. Upper part of bowl partly missing ; nozzle broken. Orange beige clay, purplish at core, finely micaceous and porous. Almost entirely smoke-blackened.

From : N Sector, occupation layer (sic!).

Parallels : ZHURAVLEV & CHRZANOVSKI 2003, p. 18 fig. 2 :2 (Berezan, turn 6th/5th c. BC) ; GALLI 2004, pl. 1 nr. 10 (type 2b, ca. 600-470/460) ; GENÇLER GÜRAY 2018, p. 38 (Type 1, end 7th to end 6th c. BC), p. 47 fig. 2 (from Erythrae).

B. 83-285 [Fig. 17 ; Pl.24]

Ber. 83-156

D. max. 7. 1 ; L. with nozzle 8. 7 ; D. base 5. 7 ; H. body 2. 5 ; H central cone 1. 3

Small lamp with incurved rim, flat bottom, raised base and pointed nozzle. Reconstructed from numerous fragments with some minor gaps. Orange clay, dark grey at core, putty-colored outside. Careless finishing. North Pontic manufacture ?

From : NW Sector, semi-dugout 24 (pottery assemblage mid- / 3rd quarter 6th c. BC).

Parallels : GALLI 2004, pl. 1 nr. 8 (type 2b, ca. 600-470/460).

Small lamps with concave-flanged bowl, central cone, slightly bulging or flat bottom

B. 62-50 [Fig. 18 ; Pl.25]

Ber. 62-31

D. max. 6. 9 ; D. rim 6. 4 ; H. body 3. 0

Small concave-flanged baggy-shaped lamp with gently carinated lower body narrowing upwards, low hollowed central cone and slightly splaying rim. Complete except nozzle broken. Bright orange clay, finely micaceous, with lime particles. Traces of soot all around the rim and preserved part of nozzle.

From : W Sector, Pit 1 of rubbish dump (pottery assemblage 6th-early 5th c. BC).

Parallels : cf. B. 69-246.

B. 69-246 [Fig. 18 ; Pl.25]

Ber. 69-366

D. max. 5. 9 ; D. rim 3. 6 ; H. bowl 2. 7 ; H. central cone 2. 5

Small concave-flanged lamp with concave shoulder, blunt slightly flaring rim and central cone. Nearly complete. Dark orange beige clay, purplish at core, finely micaceous, shimmering. Coarse finishing. Traces of soot on nozzle and nearby part of rim.

From : Sector Γ, semi-dugout (pottery assemblage 1st half 6th c. BC).

Parallels : BOITANI 1971, 266 fig. 82 nr. 1435 (type c, ca. 580/570-550) ; KASSAB & SEZER 1995, 54 nr. 89 (2nd quarter of 6th cent. BC) ; ZHURAVLEV *et al.* 2007, 111 nr. 191 (2nd half 6th-5th cent. BC).

B. 77-211 [Fig. 18 ; Pl.25]

Ber. 77-137

D. max. 4. 8 ; D. rim ;4. 45 ; D. raised base 3. 8 ; H. bowl 1. 9

Small concave-flanged lamp, flat bottom, raised base and big rounded nozzle. Complete, but very furred up. Pale orange beige clay. Nozzle unpainted. Traces of soot around nozzle and nearby part of rim.

From : NW Sector, sq. 20, occupation layer (sic!).

Parallels : KASSAB & SEZER 1995, 54 nr. 85 (1st half of 6th cent. BC).

Lamps with rounded or echinoid body, inwards folded flat rim and central cone or bulge

B. 69-109 [Fig. 19 ; Pl.26]

Ber. 69-285

D. max. 8. 0 ; pres. H. body 2. 0

Fragmentary lamp with slightly bulging body, horizontally folded flat rim and small rounded nozzle. Purplish orange clay, paler outside (self-slip ?), unmicaceous. Dark brown mat glaze : narrow band around inner rim, another one around top of shoulder and on nozzle. Traces of soot around nozzle.

From : Sector Γ, occupation layer (sic!).

Parallels : GALLI 2004, pl. 6 nr. 86, 89 (type 8a, ca. 600-525).

B. 71-116 [Fig. 19 ; Pl.26]

Ber. 71-9

D. max. 9. 5 ; D. raised base 6. 0 ; H. body 2. 5

Big lamp with echinoid body, horizontally folded rim, raised base, seemingly with central cone. Half of bowl and rim with most part of nozzle missing. Bright orange clay, purplish at core, finely micaceous, lustrous surfaced outside. Shiny dark brown glaze inside bowl halfway up and simple fillet on either side of rim. Traces of soot around nozzle attachment and nearby part of rim.

From : NW Sector, humus.

Parallels : GALLI 2004, pl. 5 nr. 72 (type 6c, ca. 530/525-490).

B. 74-85 [Fig. 19 ; Pl.26]

Ber. 74-55

D. max. 8. 0 ; H. body 2. 35 ; H. central cone 1. 85

Thin-walled lamp with rounded body, hollowed central cone and incurved rim flattened on top. Most of the rim and nozzle missing. Bright orange clay, purplish grey at core, unmicaceous. Weathered brown glaze inside the bowl, except a reserved fillet around the central cone.

From : NW Sector, recess 2, sq. 106.

Parallels : KASSAB & SEZER 1995, 61 nr. 110 (from Lindos, end 6th – 1st quarter 5th cent. BC, « Rhodian workshop »); GALLI 2004, pl. 5 nr. 76 (type 7a, ca. 550-500).

B. 74-231 [Fig. 19 ; Pl.26]

Ber. 74-141

D. max. 8. 0 ; H. body 2. 5

Lamp with echinoid body, flat inward folded rim, and horizontal handle. Large part of bowl and rim missing ; nozzle and handle broken. Bright orange

beige clay, finely micaceous, with fine dark inclusions. Remains of dark brown glaze behind broken nozzle. Traces of burning on inner rim.

From : NW Sector, occupation layer (sic!).

Parallels : see B. 74-285 *supra*.

B. 76-131 [Fig. 19 ; Pl.26]

Ber. 76-240

D. max. 9. 2 ; D. raised base 6. 6 ; H. body 2. 1 ; pres. H. central cone 1. 0

Lamp with echinoid body, broad sharply inward folded rim, low central cone and raised base. Nearly half of walls and rim with most part of nozzle missing ; tip (nipple ?) of central cone broken. Dark orange beige clay, gryish beige outside, finely micaceous, lustrous surfaced. Lustrous dark brown glaze Inside bowl and one strip between two fillets in the midst of rim. Traces of soot and burning around nozzle preserved attachment and adjoining part of rim.

From : NW Sector, sq. 107, semi-dugout (pottery assemblage 2nd half 6th c. BC).

Parallels : HOWLAND 1958, pl. 3 nr. 77 (type 12B, late 3rd and 4th quarter of 6th cent., perhaps into early years of 5th) ; GALLI 2004, pl. 5 nr. 72 (type 6c, ca. 530/525-490).

Lamps with vertical rod-handle or high-protruding funnel

B. 87-100 [Pl.27]

Ber. (-)

H. cons. 11.7 ; D. loop 4.2

Upper part of massive vertical handle topped with a suspension loop, most probably from a big multi-nozzle or even multi-stored lamp. Fine bright orange clay, buff grey inside funnel. Flaked off reoxydized black glaze. Quite a lot of archaic parallels are attested, mainly covering the 2nd half of 6th through the beginning of 5th century BC, but considering both its massiveness and fabric one cannot totally exclude either some parallel with the above-mentioned counterparts from Kyme of highly debatable Hellenistic dating¹³⁴.

From : context unspecified.

Parallels : BOITANI 1971, p. 270 fig. 84 nr. 1465 (type f, ca. 580 /570-490); DUPONT 2005b, p. 443 fig. 65 L 21 ; GALLI 2004, pl. 8 nr. 124. *Contra* : HAKEN & MARSA 1974, p. 165-166, pl. 46 (2nd c. BC).

B. 66-144 [*non vidi*] [Pl.27]

D. max. 8 ; D. raised base 4. 9 ; H. body 3. 3 ; overall H. c. 7.0.

Chimney lamp with echinoid body on raised base and flat rim overhanging inside. High-protruding conical-profiled funnel. Wide flat nozzle. Judging from the two photos at our disposal, it is not easy to appreciate the depth of the bowl

¹³⁴ The obvious perplexity of the first Czech publishers (see *supra*, note 51) lies in the fact that their finds of lamps are somewhat tentatively connected with the Hellenistic sanctuary, which might well have been preceded by an earlier one without temple, not to mention its location not far from the Northern Kymean necropolis, used as far back as the Archaic period.

and so one can hesitate between connecting it with a shallow-profiled shape of Howland's 22 type and with a deeper-profiled one of Howland's 26A type, i.e. between a 5th and a 4th/3rd century BC dating. However, the fabric seems different from the Attic one.

From : context unspecified.

Parallels : BARR 1996, 166, Fig. 4 Nr. 12 (= Howland 22B, 2nd quarter 5th c. to ca. 410 BC); HOWLAND 1958, Type 26A, p. 85-86, nrs. 365-371, pl. 13, 40 (2nd quarter 4th through early 3rd c. BC); SHEIKO 2014, p. 408, Fig. 6 : 2 (from Olbia, turn of 6th-early 5th c.BC) ; ZHURAVLEV *et al.* 2007, 166-168 Nr. 329-334 (end of 4th- 1st half of 3rd c. BC).

Howland type 19A and related

B. 67-104 [Fig. 20 ; Pl.28]

Ber. 67-165

D. max.9. 8 ; H. bowl 1. 7 ; H. funnel 1. 9

Thin-walled presumably two-nozzled chimney lamp, with shallow bowl and broad flat rim sharply folded inward. Large parts of bowl and rim with nozzle(s) missing. Orange beige clay, buff outside, finely micaceous, shimmering. Brush-painted lustrous dark brown glaze, flaking off, on rim and inside bowl.

From : Sector Γ, occupation layer (sic!).

Parallels : HOWLAND (1958), 39-40, pl. 5 nr. 131-135, pl. 33 nr. 131-132, 135-136, 139-140 (type 19A, last quarter of 6th to 480); *Tocra* II, fig. 26 nr. 2271 (D. II L. 8, c. 590-565 BC) ; KASSAB & SEZER 1995, 60 nr. 106 (Lindos, last quarter of 6th - ca. 480, Rhodian workshop ?) ; ZHURAVLEV *et al.* 2007, 31-37 nr. 1-16 (last quarter 6th - beginning or 1st quarter 5th).

B. 67-110 [Fig. 20 ; Pl.28]

Ber. 67-256

D. max. 10. 0 ; H. bowl 1. 85 ; H. funnel 2. 05

Thin-walled two-nozzled chimney lamp with shallow bowl and broad flat rim sharply folded inward. Nearly half of rim with two nozzles and parts of bowl missing. Orange beige clay, dark buff outside, finely micaceous, shimmering. Brush-painted brown glaze on rim and inside bowl, lustrous black in some places.

From : Sector Γ, basement (pottery assemblage 2nd half 6th - beginning 5th c. BC).

Parallels : *idem* see B 67-104

B. 73-31 ; Pl.28]

Ber. 73-172

D. max.10 ; H. bowl 1. 75 ; H. funnel 2. 3 ; top D. funnel 1. 7

Thin-walled chimney lamp with shallow bowl and flat rim sharply folded inward. Only one segment of rim, bowl and funnel preserved. Finely micaceous orange buff clay. Brown slip inside bowl and on flat part of lip.

From : context unspecified.

Parallels : *idem* see B 67-104

B. 77-74 [Fig. 20 ; Pl.3e & 28]

Ber. 77-120

D. max. 10. 3 ; H. bowl 1. 55 ; pres. H. funnel 1. 65

Thin-walled two-nozzled chimney lamp with shallow bowl and inward folded convex rim. One part of bowl, funnel, rim with one nozzle missing. Bright orange clay, greyish blue at core, light buff outside (self-slip), finely micaceous, shimmering. Lustrous surfaced underneath. Shiny diluted dark brown glaze inside bowl and on funnel as well as on both nozzles by dipping. Type Howland 19A variant, but finer fabric.

From : NW Sector, sq. 34, recess (pottery assemblage 1st half / mid-6th c. BC).

Parallels : Type Howland 19A variant of finer fabric, also attested in Histria among the former unpublished Lambrino finds.

B. 79-58 [Fig. 20 ; Pl.28]

Ber. 79-56

D. max. 9. 1 ; H. bowl 2. 2 ; H. funnel 1. 9

Thin-walled chimney lamp with shallow bowl and inward sharply folded rim. Large parts of bowl and rim missing ; nozzle broken. Bright orange clay, purplish beige at core, orange beige outside, sparingly micaceous. Brush-painted lustrous dark brown glaze on rim, nozzles and inside bowl.

From : NW Sector, sq. 48-61, recess.

Parallels : see B. 67-104.

B. 82-76 [Fig. 21 ; Pl.29]

Ber 82-12 + Ber. 82-190

D. max 9. 3 ; H. body 1. 95 ; h. chimney 1. 85

Thin-walled two-nozzled chimney lamp with shallow bowl and flat rim horizontally folded inward. Fragmentary, parts of one nozzle, bowl and rim missing. Orange / greyish light brown clay, very micaceous (mica flakes), shimmering in surface. Traces of soot around both nozzles. Type HOWLAND 1958 19A, variant of Howland type 19A.

From : NW Sector, well (pottery assemblage 2nd half 6th / beginning 5th c. BC).

Parallels : HOWLAND 1958, pl. 5 nr. 135 (type 19A, variant); ZHURAVLEV *et al.* 2007, 37 nr. 17.

B. 85-146 [Fig. 21 ; Pl.29]

Ber. 85-27

D. max. 10. 0 ; H. bowl 2. 1

Thin-walled two-nozzled (?) chimney lamp with shallow bowl, flat rim sharply folded inward and broad rounded nozzle. Mostpart of bowl and rim missing. Orange clay, light grey at core, orange beige outside., finely micaceous but hardly shimmering. Brush-painted dark brown glaze, vaguely lustrous, on rim and inside bowl. Traces of soot around nozzle.

From : NW Sector, occupation layer (sic!).

Parallels : see B. 67-104

B. 87-36 [Fig. 21; Pl.29]

Ber. 87-30

D. max. 10. 0 ; H. bowl. 1.6

Thin-walled two-nozzled (?) chimney (?) lamp with shallow bowl, flat rim horizontally folded, and broad rounded nozzle. Most part of bowl with chimney missing ; one nozzle preserved. Bright orange clay, dark beige outside, finely micaceous (with fine mica flakes), shimmering. Lustrous brush-painted orange brown glaze on rim and inside bowl. Traces of soot around nozzle. Type Howland 19A, variant of Howland type 19A.

From : NW Sector, occupation layer (sic!).

Parallels : ZHURAVLEV *et al.* 2007, 37 nr. 17.

Lamps with swollen body and broad flattened rim slightly projecting outwards

B. 65-107 ; [Pl.30]

Ber 65-157

D. max. (rim) 10. 0

Lamp with swollen body and broad flattened horizontal rim slightly protruding outwards and surrounded by a thin fillet. Fragment of rim and bowl with right end of nozzle. Orange beige clay, purplish grey at core, paler outside. Brown glaze : 6 concentric fillets on rim and nozzle by dipping. Corinthian / corinthianizing ?

From : context unspecified.

Parallels : HOWLAND 1958, p. 30-31 (Type 16A = Broneer Type II, « *as early as the early 6th cent. BC and well into the 3rd quarter of the century* »), pl. 4 nr. 92, 32 nr. 92 ; GALLI 2004, pl. 2 nr. 22-26 (type 4 var. a, ca. 600-550) or 7 nr. 102 (type 9 var. b, ca. 600-525), 107 (type 10 var. a, ca. 525-480) ; ZHURAVLEV & CHRZANOVSKI 2003, p. 17, fig. 1 : 3 (Berezan).

B. 75-93 [Fig. 22 ; Pl.30]

Ber. 75-181

D. max. 8. 5 ; H. body : 1. 9

Fragmentary lamp with rounded body, central cone and flattened overhanging rim, made of pale clay. Half of body with most part of nozzle missing. Unmicaceous pinkish beige clay, paler near surface. Red brick glaze, partly turned to brown : 4 concentric fillets around central cone ; on flat part of rim, 3 thick concentric fillets separated by double thin ones. Traces of soot around nozzle. Corinthian / corinthianizing ?

From : NW Sector, humus.

Parallels : see *supra* B. 65-107.

B. 75-95 [Fig. 22 ; Pl.30]

Ber. 75-231

D. max. 8. 2 ; D. base 6. 4H. body 2. 2 ; H. central cone 2. 15

Lamp with rounded body, central cone and flattened overhanging rim. Nozzle and small piece of rim and bowl missing. Unmicaceous pinkish beige clay,

paler near surface. Brick red glaze, partly turned to brown, covering bowl and central cone and, on flat part of rim, purplish band between concentric brown fillets. Lustrous surface. Corinthian / corinthianizing ?

From : NW Sector, basement (pottery assemblage late 6th c. BC).

Parallels : see *supra* B. 65-107 & B. 75-93.

B. 74-89 [Fig. 22 ; Pl.30]

Ber. 74-136

D. max. 8. 9 ; D. rim 8. 75 ; H. body 1. 9

Lamp with rounded body, slightly bulging bottom, concave base and broad flat overhanging rim, slightly projecting outwards. Large part of outer bowl and rim together with nozzle missing. Orange clay, purplish at core, paler outside, finely micaceous, shimmering. Dark brown to buff glaze, lustrous to mat. Careless finishing. Misfired Attic or North-Pontic imitation ?

From : NW Sector, humus.

Parallels : HOWLAND 1958, p. 31-33 (type 16B, last quarter 6th c. down to 480 BC), pl. 4 nr. 94-98, 32 nr. 94-105 ; *Tocra* II, fig. 26 nr. 2274 (L. 5/6, Attic, ca. 500-480 BC) ; GALLI 2004, pl. 7 nr. 107-110 (type 10a, ca. 526-480 BC).

B. 91-107 [Fig. 22 ; Pl.30]

Ber. 91-64

D. max. (rim) 9. 3 ; D. bowl 9. 05 ; D. base 7. 1 ; H. body 2. 65 ; H. central cone 0. 6

Black-glazed lamp with swollen outline, low central cone on concave base, and flattened overhanging rim, strongly projecting inward and slightly outward. Nearly complete, except nozzle broken. Orange clay, finely micaceous, shimmering, lustrous surfaced. Shiny black glaze, partly reoxydized in light brown inside bowl and on rim. Attic / Atticizing ? Howland type 16B.

From : NW Sector, House 7, room 3 (pottery assemblage 2nd half 6th / 1st third 5th c. BC).

Parallels : *Tocra* II, fig. 26 nr. 2274 (Attic, Howland type 16 variant, ca. 500-480) ; BAILEY 1975, pl. 77 nr. Q.375 (Rhodes, in the generation before of after 500, similarity to Athenian lamps of HOWLAND 1958 type 16B) ; CHRZANOVSKI & ZHURAVLEV 1998, 35 nr. 3 (Chersonesus, similar to the Athenian lamps of Howland type 16 variant, which are dated from the 2nd half of the 6th to the second decade of 5th cent. BC) ; ZHURALEV *et al.* 2007, 58-60 nrs. 76-79.

B. 91-108 ; [Pl.30]

Ber. 91-65

D. max. (bowl) 9. 5 ; D. rim 9. 0 ; D. base 7. 6 ; H. bowl 2. 45.

Same type as B. 91-107. Fragmentary : one part of bowl and rim with complete nozzle preserved. Big round nozzle. Same clay and glaze as preceding. Traces of soot around nozzle. Attic / Atticizing ?, Howland type 16B.

From : NW Sector, House 7, room 3 (2nd half 6th - 1st third 5th c. BC).

Parallels : see B. 91-107.

B. 91-167 [*non vidi*] Pl.30]

From : context unspecified.

Same shape and type as B. 91-107 and 108 / graffito ΕΣ.

Grey lamps**B. 63-326** ; [Pl.34]

Ber. 63-57

D. estim. ca. 13 ; H. bowl 2. 3

Coarse grey chimney lamp, with echinoid body, flattened rim, slightly protruding out- and inwards, and pointed nozzle. Nearly one third of body opposite nozzle missing, as well as two thirds of rim. Fine buff grey clay. Thick brush-painted dull black glaze inside bowl and on rim. Careless finishing.

From : context unspecified. (same pottery box 21 as candlestick B. 63-234).

Parallels : GALLI 2004, pl. 2 nr. 23, 26, 28 (type 4a, ca. 600-550).

B. 64-208 [Fig. 23 ; [Pls. 5b & 31]

Ber. 64-310 (?)

D. max. (rim) 9. 15 ; H. body

Two-nozzled grey lamp, with echinoid body, convex base, inward slanting rim and lateral horizontal peak arching handle. Nearly half of body and most part of one nozzle missing. Dark grey stratified clay, finely micaceous, with numerous fine limestone particles. Lustrous blackish slip, over whole surface except on convex base. Traces of soot around preserved nozzle. Found together with a button-foot of grey bowl of North-Ionian type.

From : Sector Γ, occupation layer (sic!).

Parallels : ZABELINA 1992, 300 pl. 1 : 1, with flat base (Panticapaion, end of 6th cent. BC) ; CHRZANOVSKI & ZHURAVLEV 1998, nr. 5 (Chersonese, local production, 5th or even late 6th, till 3rd cent. BC); ZHURAVLEV *et al.* 2007, p. 149 nr. 289 (Nymphaion, var. with concave base). Same type as B. 72-199, B. 89-149 and B. 90-102.

B. 65-277 [Pl.32]

Ber. 65-217

D. 9 ; H. bowl 2 ; D. handle 1. 2

Smoothly carinated grey lamp of biconical profile, most probably flat-bottomed, fitted with lateral round handle. Greater part of bowl and rim missing. Fine light grey clay with lime grits. Surface medium grey (self slip ?). Aeolian type.

From : context unspecified.

Parallels : GALLI 2004, pl. 8 nr. 120, but more angular profiled as B. 89-100 *supra*.

B. 65-275 [Pl.34]

(-)

D. 22 ; H. body 2. 9

Grey chimney lamp, with rounded body and incurved rim. Two thirds of

body and rim missing ; funnel and nozzle half broken. Finely micaceous medium grey clay, slightly reoxydized near surface. Lustrous dark grey slip inside bowl and upper half outside. Graffito [=]-shaped under bowl near nozzle.

From : context unspecified.

Parallels : same type as B. 63-326 *supra*.

B. 67-159 [Fig. 23 ; Pl.33]

Ber. 67-234

D. max. 7. 0 ; L. max. with nozzle 8. 3 ; H. body 2. 1

Coarse small grey lamp with incurved rim and flat bottom. Complete. Medium grey clay, finely micaceous. Small rounded nozzle with oval hole.

From : Sector Г, occupation layer (sic!).

Parallels : GALLI 2004, pl. 8 nr. 119.

B. 68-104 [Fig. 23 ; Pl.33]

Ber. 68-7

D. max. 6. 4 ; D. base 3. 9 ; L. max. with nozzle 7. 65 ; H. body 1. 9

Small coarse grey lamp with echinoid body, flat base, slightly concave, and incurved rim. Greyish brown clay, discreetly micaceous. Traces of soot around nozzle.

From : Area B6, humus.

Parallels : GALLI 2004, pl. 1 n° 7 (type 2b, ca. 600-470/460).

B. 72-199 [Fig. 23 ; Pls. 5a & 31]

Ber. 72-44

D. max. 9 ; L. max. with nozzles 12. 0 ; H. bowl 2. 7

Two-nozzled grey lamp with echinoid bowl, convex base, inward folded rim and horizontal lateral peak arching handle. Complete. Medium grey clay, finely micaceous, slightly lustrous surfaced. Careless finishing. Pontic manufacture ?

From : NW Sector, Pit 11 (pottery assemblage mid- / 2nd half 6th c. BC).

Parallels : same type as B. 64-208, B. 89-149 and B. 90-102

B. 76-270 [Fig. 24 ; Pls. 6a & 35]

Ber. 76-315 + 337

D. max. 11. 0 ; H. bowl 2. 5 ; H central cone 2. 7

Big three-nozzled grey lamp with echinoid bowl, flat inward folded rim and hollowed central cone. The three broad nozzles are flanked with a plastic lug on either side. Completed of two fitting parts. Light grey clay, finely micaceous, lustrous surfaced.

From : NW Sector, occupation layer (sic!).

Parallels : KHUDYAK 1962, pl. 37 : 4 (Nymphaion, grey ware, mid 6th cent.) ; SHEIKO 2016, p. 84 fig. 4 : 1 (from Berezan, together with another specimen of chimney-type).

B. 77-175 [Fig. 24];

Ber. 77-223

D. max. 10. 0 ; D. rim 9. 7 ; D. base 9. 0 ; H. body 2. 7 ; H. central cone 3. 8

Big grey lamp with swollen body, thickened rim and high protruding central cone. Broad piece of bowl and rim missing ; nozzle broken. Medium grey clay, finely micaceous. Traces of soot around nozzle. North Pontic manufacture ?

From : W Sector, occupation layer (sic!).

Parallels : KASSAB & SEZER 1995, 55-56 nr. 91 (Ephesus, end of 6th c. BC), 58 nr. 99 (Lembet, 2nd half of 6th c. BC), though both in orange clay ; ZHURAVLEV *et al.* 2007, p. 110 nr. 190 (Mirmekion, 2nd half 6th-1st quarter 5th c. BC), also brown clay.

B. 83-112 [Fig. 25 ; Pl.33]

Ber. 83-770

D. max 10. 0 ; H body 2. 0

Fragmentary big grey lamp with folded rim inward slanting, slightly bulging bottom and flat base. Traces of soot around nozzle. Porous light grey clay, finely micaceous, with limestone grits. Unslipped.

From : NW Sector, occupation layer (sic!).

Parallels : same type as B. 72-199 *supra*.

B. 85-147 [Fig. 25 ; Pl.33]

Ber. 85148

D. max. 9. 0 ; H. body 1. 9

Grey lamp with echinoid body, incurved rim, strong rounded nozzle, slightly bulging bottom, flat base. More than one half of bowl and rim missing (maybe together with second opposite nozzle and lateral handle ?). Dark grey clay, finely micaceous. Lustrous blackish coating on outer body and bottom of bowl. Careless finishing.

From : NW Sector, Roman dugout, sq. 863.

Parallels : same type as B. 72-199 et B. 89-149 but with incurved rim

B. 89-149 [Fig. 25 ; Pl.32]

Ber. 89-63

D. max. 8. 0 ; H. body 2. 2

Two-nozzled (?) grey lamp with echinoid body, inward folded rim, slightly bulging bottom, flat base and lateral horizontal handle, peak arching and raising up. Larger part of upper body with one nozzle missing. Medium grey clay, finely micaceous. Lustrous black coating outside and inner bowl. Neglected finishing.

From : NW Sector, Pit 54 (pottery assemblage last quarter 6th - 1st third 5th c. BC).

Parallels : same type as B. 64-208, B. 72-199 and B. 90-102

B. 90-102 [Fig. 25 ; Pl.32]

Ber. 90-167

D. max 10. 6 ; D. base 6. 4 ; D. body 2. 6 ; oval handle 1. 6 x 1. 1

Fragmentary two-nozzled (?) grey lamp with low echinoid body, folded flat rim, inward slanting, bulging bottom and lateral horizontal handle. Traces of soot around nozzles. Fine porous light grey clay. Blackish brush painted slip on inner bowl, rim and handle.

From : NW Sector, semi-dugout 59 (pottery assemblage 3rd quarter 6th c. BC).

Parallels : same type as B. 64-208, B. 72-199 and B. 89-149.

B. 252 [Fig. 25 ; Pl.33]

Berezan 1908

D. max. 6. 1 ; H. body 2. 1

Small grey lamp with rounded body, incurved rim, slightly bulging bottom and concave base. Complete. Dark grey clay, sparingly micaceous with small lime particles. Coarse manufacture.

From : Excavations E . R. Stern 1908, Sector B8, Pit 4.

Parallels : GALLI 2004, pl. 7 nr. 113 (type 10c, ca 500-460).

B. 66-158 ; Pl.35]

Ber. 66-288

D. max. 7. 4 ; D. rim 5 ; H. 3. 2 ; H. bowl 2

Flat bottomed grey lamp with echinoid bowl pulled into collar around filling-hole. Half part of body missing ; nozzle broken at base with initial section of wick-hole. Plain light grey porous clay, finely micaceous. Careless finishing. The shape is quite unusual and might be related with another undetermined specimen from Gravisca topped by a lower collar. The connection with an additional odd shape from the Agora appears unlikely judging from its weak-based late dating.

From : context unspecified.

Parallels : GALLI 2004, pl. 8 Nr. 120 ; HOWLAND 1958, p. 115-116 nr. 487, pls. 17 & 44 (2nd half of 4th c. BC).

Straight-flanged raised based lamps with inward sloping flat rim and central cone or chimney (n. Howland 19 variants)

B. 64-105 [Pl.37]

Ber. 64-250

D. max. (rim) 8. 0 ; D. bowl 7. 7 ; D. raised base 6. 1 ; H. body 2. 2

Straight-flanged lamp, rounded below, with raised base, presumably central cone and inward folded flat rim. Greater part of bowl and rim with nozzle missing. Orange beige clay, purplish at core, finely micaceous, shimmering. Brush-painted shiny dark glaze Inside whole bowl and traces of two fillets on either side of rim. Attique ?

From : context unspecified.

Parallels : GALLI 2004, pl. 4 nr. 67 (type 6b, ca. 530/525-490).

B. 65-118 [Fig. 27 ; Pl.37]

Ber. 65-382

D. max. 8. 6 ; D. rim 8. 3 ; D. base 5. 7 ; H. body 2. 2 ; H. central cone 1. 5

Slightly slanting straight-flanged lamp on raised base, with hollowed central cone and inward folded flat rim. Most part of nozzle missing. Fine orange beige clay, finely micaceous. Brush-painted brown glaze inside bowl and thin fillet around inner side of rim. Traces of soot around nozzle. Attic ?

From : N Sector, occupation layer (sic!).

Parallels : *Tocra II*, fig. 26 nr. 2273 (D. III L. 7, 565-520/510).

B. 71-120 [Fig. 27 ; Pl.37]

Ber. 71-150

D. max. 7. 0 ; D. raised base 5.0 ; H. body 2. 1

Lamp with straight upward splaying body, thick flattened inward slanting rim and raised base. Section of rim and bowl with complete nozzle. Beige clay, darker at core pale outside (self-slip), finely micaceous, shimmering. Shiny dark brown glaze inside whole bowl as well as one fillet on either side of rim and nozzle by dipping. Traces of soot around nozzle.

From : NW Sector, occupation layer (sic!).

Parallels : GALLI 2004, pl. 5 nr. 71-72 (type 6c, ca. 530/525 - 490).

B. 73-204 [Fig. 27 ; Pl.37]

Ber. 73-480

D. max. 9. 0 ; D. raised base 7. 2 ; pres. H. 2. 35

Lamp with upward flaring bowl and broad rim sharply folded inward. Fragment of rim and shoulder, seemingly fitting though not joining with another fragment of bottom with raised base. Light beige clay, pinkish beige at core, unmicaceous. Lustrous light buff slip. Lustrous brown glaze, mostly washed out: bottom of bowl, central band between double fillets on rim.

From : W Sector, Pit 5 (pottery assemblage mid- / 3rd quarter 6th c. BC).

Parallels : see B. 74-90.

B. 74-90 [Fig. 27 ; Pl.37]

Ber. 74-149

D. max. 8. 5 ; D. raised base 5. 8 ; H. body 2. 2 ; H. central cone 2. 0

Lamp with downward narrowing body, raised base, sharply folded inward slanting rim and hollowed central cone. Most part of nozzle missing. Orange beige clay, slightly purplish at core, finely micaceous with lime particles. Lustrous yellowish coating or selfslip. Dark brown glaze, mostly flaking off : inner bowl and narrow band between two fillets on rim. Traces of soot around nozzle.

From : NW Sector, sq. 5, recess 1 (pottery assemblage 2nd quarter 6th c. BC).

Parallels : GALLI 2004, pl. 5 nr. 71-72 (type 6c, ca. 530 / 525-490 BC). Type also attested in Histria with two better preserved pieces (Lambrino excavations 1927-1942, one of them bearing the inv. nr. B. 2437, both unpublished), with bell-shaped bowl on raised base, hollowed central cone and similar sharply folded rim.

B. 79-74 [Fig. 27 ; Pl.38]

Ber. 79-189

D. max. 7. 6 ; D. rim 6. 9 ; D. raised base 6. 6 ; H. body 2. 3 ; H. funnel 2. 3

Squat chimney lamp, with swell-flanged bowl on raised base and horizontally inward folded concave rim. One part of outer bowl with nozzle missing. Bright orange clay, purplish at core, paler outside, sparingly micaceous. Underside of raised base burnished. Lustrous brown glaze : inner bowl and funnel ; double narrow band on rim ; fillet on inner edge of rim ; shoulder fillet

outside. Attic ?

From : NW Sector, occupation layer (sic!).

Parallels : HOWLAND 1958, pl. 3 nr. 77, var. with central cone (type 12b, « Late 3rd and 4th quarters of 6th century BC, perhaps into early years of 5th »; GALLI 2004, pl. 6 nr. 90 (type 8b, ca. 525-480).

B. 82-158 [Fig. 26 ; Pl.37]

Ber. 82-52

D. max. 7. 4 ; D. base 6. 7 ; H. body 1. 9 ; H. central cone 0. 8

Straight-flanged lamp with splaying body, horizontally inward folded rim, low central cone and horizontal handle opposite the heavy nozzle. Nearly complete ; most part of handle broken. Orange beige clay, bright orange underside, with scattered fine mica flakes. Glossy dark brown glaze on nozzle by dipping. Traces of soot around nozzle.

From : NW Sector, sq. 767, humus.

Parallels : GALLI 2004, pl. 4 nr. 66, 68 (type 6b, ca. 530/525-490) ; SHEIKO 2016, p. 82 fig. 3 : 1-2 (from Berezan).

B. 82-159 [Fig. 27 ; Pl.37]

Ber. 82-10

D. max. 8. 5 ; D. ring foot 4. 5 ; H. body 2.3 ; pres. H. central cone 1. 2

Straight-flanged lamp, most probably two-nozzled, with slightly splaying body inward horizontally folded rim, central cone and narrow ring base, triangular in section. One half of bowl and rim missing as well as nozzle. Bright orange clay, paler outside, sparingly micaceous. Lustrous surface. Glossy brown glaze, mostly washed out, inside bowl, supplemented by two concentric fillets on rim. Traces of soot, diametrically opposed, on rim edge.

From : NW Sector, sq. 718, well (pottery assemblage 2nd half 6th / beginning 5th c. BC).

Parallels : GALLI 2004, pl. 5 nr. 71-72 (type 6c, ca. 530/525-490).

B. 82-169 [Fig. 26 ; Pl.36]

Ber. 82-255

D. max. 8. 25 ; D. base 6. 4 ; H. body 2. 5 ; H. central cone 2. 1

Big straight-flanged lamp with splaying bowl, sharply inward folded grooved rim sharply edged and high central cone. Nearly complete, except end of nozzle broken. Orange beige clay, purplish at core, bright orange underside, light buff outside (self-slip), finely micaceous, shimmering. Brown glaze : bottom of bowl and 3 concentric fillets on rim ; nozzle by dipping. Careless manufacture. Traces of soot around nozzle and nearby rim.

From : NW Sector, semi-dugout 25 (pottery assemblage 2nd quarter 6th c. BC).

Parallels : GALLI 2004, 46 pl. 4 nr. 66, 68 (type 6b, ca. 530/525-490).

B. 82-170 [Fig. 26 ; Pl.38]

Ber. 82-78

D. max. 8. 7 ; D. base 7. 5 ; L. with nozzle 11. 2 ; H. body 2. 5 ; H. central cone 2. 0

Big straight-flanged thick-walled lamp with splaying bowl, sharply inward folded twin-grooved rim, hollowed central cone and nozzle flanked by two side lugs. Part of bowl and rim missing. Bright orange clay, greyish beige at core, light buff outside (self-slip), finely micaceous plus scattered flakes, shimmering. Burnished base. Lustrous brown glaze : bottom of bowl and two concentric bands on rim ; nozzle by dipping. No traces of soot.

From : NW Sector, sq. 768, recess of Roman time.

Parallels : same type (and workshop ?) as B. 82-169, but with additional lugs.

B. 86-51 [Fig. 26 ; Pl.38]

Ber. 86-307

D. max. 8. 5 ; D. raised base 5. 8 ; H. body 2. 2 ; H. central cone 2. 1

Thin-walled straight-flanged lamp with downward constricting body, gently carinated below, and high central cone. Nozzle broken. Orange beige clay, purplish at core, finely micaceous, shimmering. Brush-painted glossy brownish glaze : inside of bowl, nozzle and band mid-rim and thin fillet on edge of rim. Traces of soot around nozzle.

From : NW Sector, sq. 12, Pit 1 (pottery assemblage 3rd quarter 6th c. BC).

Parallels : GALLI 2004, pl. 7 nr. 104-105 (type 9b, ca. 600-525).

Chimney lamp with swollen body and narrow overhanging rim ridged inside (Howland 17A variant ?)

B. 77-181 [Fig. 27];

Ber. 77-87

D. max. 7. 5 ; D. rim 7. 0 ; H. body 2. 4 ; H. funnel 2. 4

Small grey chimney lamp with swollen body, slender funnel, slightly elevated nozzle and narrow inward slanting rim ridge-lined inside. Nearly complete except broken nozzle. Greyish light beige clay, finely micaceous, with small darkgrits. Careless finishing. Traces of soot around nozzle.

From : NW Sector, sq. 21, occupation layer (sic!).

Parallels : North Pontic manufacture ? A similar piece from Histria has revealed a local chemical pattern. The general profile recalls Howland's type 17A (late 6th down to ca. 480 BC), but with flat rim ridged only inside.

Simple straight-flanged open lamps

B. 368 [Fig. 28 ; Pl.36]

D. max. 7. 2 ; H. bowl 2. 0

Straight-flanged chimney (?) lamp, narrow rim slightly bulging inward, with incised inscription all around the outside of the body: « Ως λυκνον εμυ, και φαινω θεοισιν καθρωποισιν » (« *As I am a lamp, I provide light as well to gods as to men* ») a verse referred to Hipponax of Ephesus (2nd half of 6th c. BC). Most part of bottom and large parts of walls and rim missing; end of nozzle broken. Orange beige clay, greyish at core, sparingly micaceous.

From : context unspecified.

Parallels : BOARDMAN 1967, 234 fig. 154 nr. 497 (Period II, Late 6th to most of 4th cent.) ; BAILEY 1975, pl. 138 Q 745, Q 746 (unattributed type) ; HØJTE 2010, vol. 1, p. 131 nr. O-51 (O = Olbia), vol. 2, pl. 322 (from context unclear, dated 4th c. BC but found mixed with Archaic and Classical sherds).

Inscription : AA 1910, col. 226, fig. 26 ; DUBOIS 1996, 80 n° 39 (c. 550-525).

B. 72-112 [Fig. 28 ; Pl.36]

Ber. 72-85

D. max. 7. 5 ; D. rim 7. 5 ; H. bowl 2. 2 ; H. funnel 2. 2.

Straight-walled chimney lamp with nearly vertical sides and blunt-edged rim. Two thirds or so of bowl and rim with nozzle missing. Orange beige clay, purplish at core, finely micaceous, shimmering.

From : NW Sector, humus.

Parallels : see B.368.

B. 82-177 [Fig. 28 ; Pl.36]

Ber. 82-261

D. 7. 0 ; pres. H. 2. 05

Small thin-walled lamp, with widely open straight-flanged bowl, and blunt, slightly thickened rim. Fragment of rim and bowl. Yellowish clay, pinkish at core, porous. North-Pontic product ?

From : NW Sector, semi-dugout 24 (pottery assemblage beginning 6th c. BC).

Parallels : see B. 368

Candlesticks ancestors

B. 63-234 ; [Pl.39]

Regist. 148

D. funnel 3. 3 ; H. 2. 5 ; D. ring-foot 5. 1

Abnormal ring-footed chimney lamp or candlestick, with two diametrically opposite small rectangular holes at the base of the blind central tube which is only attached to the bottom of the bowl and not pierced through. Only the central part of the bowl with complete funnel is preserved. Finely micaceous orange beige clay. Brick painted inside bowl. Outside of central tube covered with soot, upper edge thickly encrusted.

From : context unspecified (same pottery box 21 as candlestick B. 63-226 in deposit).

Parallels : none found for the Greek period.

B. 87-106 ; [Pl.39]

Ber. 87-195

D. funnel 2. 5 ; H. 1. 9

Abnormal coarse chimney lamp or candlestick, with central tube cut-off into two parts by two diametrically opposite notches. Only the central part of the bowl is preserved. Thick-walled bottom with flat base. Central tube thickly encrusted with a glossy soot extending onto the bowl. Fine greyish orange beige clay with dark inclusions.

Context : from semi-dugout 48, in use during the span late 5th / first decade of the 4th centuries BC after SOLOVYOV 1995.

Parallels : none found for the Classical period.

B. 88-44 [Fig. 29 ; Pl.39]

Ber. 88-88

D. flat base 6. 5 ; H. 3. 45 ; D. funnel 3. 5 (above) / 3. 1 (below)

Abnormal light grey chimney lamp or candlestick, with two diametrically opposite small round holes at the base of the blind central tube which is only attached to the bottom of the bowl and not pierced through. Only the central part of the bowl with complete funnel is preserved. Thick-walled bottom with convex base. Finely micaceous greyish beige clay. Bowl and chimney brush painted in dark brown lustrous slip.

From : NW Sector, humus.

Parallels : BAILEY 1988, 172 Q 1650-1653, pl. 10 ; GOETHERT 1997, nr. 115, fig. 92-93 (Loeschke type XIV, 1st-3rd cent. AD).

Native handmade open lamp

B. 74-224 [Fig. 29 ; Pl.40]

Ber. 74-161

D. max. 6. 8 ; D. base 2. 9 ; D. handle 0. 8 ; H. 2. 8 / 3. 0

Handmade open lamp with rounded body, shallow bowl and horizontal handle. Nearly one third of bowl opposite handle missing. Coarse orange buff clay with glossy black inclusions and lime grits. Lustrous smoked buff grey surface. Coarse finishing.

From : NW Sector, sq. 108, occupation layer (sic!).

Parallels : usually, native handmade lamps are not fitted with handle (see WALDHAUER 1914, pl. X : 1-5 ; MARCHENKO 1988, p. 101 fig. 32 : 5-6, 8, 11-12, 14). This one is probably imitating simple one nozzled Greek shapes.

Isolated instances of Roman intrusions

B.479 [Fig. 29 ; Pl.40]

Ø max. 9. 1 ; D. discus 4. 5 ; pres. H. 3. 0

Mould made Roman lamp with carinated body, flat bottom and concave discus with 12 petals rosette decoration. Sloping nozzle broken. Greyish buff clay, dull beige slip.

From : Excavations E. R. Stern 1910, context unspecified.

Parallels : ICONOMU 1967, p. 121 nr. 532 fig. 129 (type XX, from Tomis, 2nd-3rd c. AD) ; CHRZANOVSKI & ZHURAVLEV 1998, 99 nr. 50 (Loeschke type VIII, 2nd c. AD) ; TOPOLEANU & CROITORU 2015, p. 105-106 nr. 25 (Loeschke type VIII R, from Callatis, 1st - 2nd c. AD).

B. 69-235 [Fig. 29 ; Pl.40]

Ber. 69-235 (Berezan season 1900)

D. max. 8. 4 ; H. 2. 7

Small mould made Roman lamp with carinated body and coarse relief decoration : frieze of radial ribs on shoulder and medallion of radial ribs on bottom. Pale beige fine clay. Traces of dull brick red glaze. Nozzle broken.

From : Sector Г, occupation layer (sic!).

Parallels : ICONOMU 1967, p. 132 nr. 683 fig. 155 (type XXVI, from Tomis, 3rd-4th c. AD); CHRZANOVSKI & ZHURAVLEV 1998, p. 133-140, Nr. 75-79 (« *sunburst* » / « *rubchatye* » lamps, 3rd / 4th c. AD); TOPOLEANU & CROITORU 2015, p. 148-149 nr. 42 (Loeschke type VIII, 2nd-4th c. AD, from Callatis).

BIBLIOGRAPHY

AKURGAL 1983 - E. Akurgal, *Altsmyrna I. Wohnschichten und Athenatempel*, Ankara, 1983.

BAILEY 1975 - D. M. Bailey, *A Catalogue of the Lamps in the British Museum I. Greek, Hellenistic and Early Roman Pottery Lamps*, London, 1975.

BAILEY 1988 - D. M. Bailey, *A Catalogue of the Lamps in the British Museum. III Roman provincial lamps*, London, 1988.

BAILEY 1991 - D. M. Bailey, *Aegina, Aphaia-Tempel, XIV. The lamps*, AA 1991, p. 31-68.

BARR 1996 - R. L. Barr, *Greek and Hellenistic Lamps from Ilion*, *Studia Troica* 6 (1996), p. 160-200.

BELOV 1972 - G. D. Belov, *Ioniskaya keramika iz Khersonesa*, *Trudy Gosudarstvennogo Ermitazha* 13 (1972), p. 17-26.

BLAVATSKII 1953 - V. D. Blavatskii, *Zemledelie v Antichnykh Gosudarstvakh Severnogo Prichernomor'ya*, Moscow, 1953.

BLINKENBERG 1931 - Chr. Blinkenberg, *Lindos. Fouilles de l'acropole 1902-1914. I. Les petits objets*, Berlin, 1931.

BLONDÉ 1983 - F. Blondé, *Greek Lamps from Thorikos, I*, Gent, 1983.

BOARDMAN 1967 - *Excavations in Chios 1952-1955. Greek Emporio*, BSA Suppl. 6, 1967.

BOITANI 1971 - F. Boitani, *Lucerne in : Gravisca (Tarquinia). Scavi nella citta etrusca e romana*, NSc 25, 1971, p. 262-285.

CHISTOV 2012 - D.E. Chistov (ed.), *Materialy Berezanskoi (Nizhnebugskoi) antichnoi arkhelogicheskoi ekspeditsii, T. 2*, St. Petersburg, 2012.

CHRZANOVSKI & ZHURAVLEV 1998 - L. Chrzanovski, D. Zhuravlev, *Lamps from Chersonesos in the State Historical Museum – Moscow*, Rome, 1998.

Clara Rhodos VI-VII - G. Jacopi (ed.), *Scavi e Ricerche di Nisiro, Clara Rhodos VI-VII*, Rhodes, 1932-1933.

DAMYANOV 2018 - M. Damyanov, *Svetilishcheto na Demetra v Apoloniya v Chernomorski kontekst*, in: I. Valchev (ed.), *Stephanos Archaeologicos ad 80 annum Professoris Ludmili Getov*, *Studia Archaeologica Universitatis Serdicensis*, Suppl. 6, Sofia (2018), p. 93-108.

DIMITRIU 1966 - S. Dimitriu, *Cartierul de locuințe din zona de vest a cetății în epoca arhaică. Săpături 1955-1960*, in: E. Condurachi (ed.), *Histria II*, Bucurest, 1966, p. 19-132.

DUBOIS 1996 - L. Dubois, *Inscriptions grecques dialectales d'Olbia du Pont*, Genève, 1996.

DUPONT 2005a - P. Dupont, *Les lampes ioniennes archaïques de mer Noire*, in : L. Chrzanovski (ed.), *Lychnological Acts 1, Actes du 1^{er} Congrès international*

d'études sur le luminaire antique, Lyon-Genève, 2003, p. 73-79, pls. 31-32 (=Monographies *Instrumentum* 31, Montagnac, 2005, p. 73-79).

DUPONT 2005b - P. Dupont, *Catalogue des lampes grecques archaïques de la "Zone Sacrée" d'Istros*, in: P. Alexandrescu (ed.), *Histria VII. La Zone Sacrée d'époque grecque*, Bucarest, 2005, p. 433-444.

DUPONT 2013 - P. Dupont (with the collaboration of S. Solovyov), *Chimney lamps or candlesticks? Three odd lighting devices from Berezan in the Hermitage collection*, in: A. N. Kovalenko (éd.), *Black Sea region in Antiquity and early Middle-Ages. Papers presented to V. P. Kopylov on the occasion of his 65th birthday*, Rostov-on-Don, 2013, p. 59-61.

DUPONT 2019 - P. Dupont, *Note sur les moyens d'éclairage domestique des colons grecs du Pont –Nord*, *Materiale și Cercetări Arheologice* (N. S.), 15 (2019), p. 81-84.

ERSÖY 1993 - Y. E. Ersöy, *Clazomenae: The Archaic settlement*, PhD. Bryn Mawr College, 1993.

FORBES 1955 - R. J. Forbes, *Studies in Ancient Technology*, Vol. I, Leiden, 1955.

FORBES 1966 - R. J. Forbes, *Studies in Ancient Technology*, Vol. VI, Leiden, 1966.

FURTWÄNGLER 1906 - A. Furtwängler, *Aegina*, München, 1906.

FURTWÄNGLER 1980 - A. Furtwängler, *Heraion von Samos: Grabungen im Südtemenos 1977*, I, AM 95.

FURTWÄNGLER & KIENAST 1989 - A. Furtwängler & H. Kienast, *Der Nordbau im Heraion von Samos*, Samos III, 1989.

GABRICI 1927 - E. Gabrici, *Il Santuario della Malophoros a Selinunte*, Mon. Ant. 32, 1927.

GALLI 2004 - V. Galli, *Le lucerne greche e locali*, = *Gravisca* 11, Bari, 2004.

GENÇLER GÜRAY 2018 - Ç. Gençler Güray, *Erythrai – Cennettepe kazıları yapımı kandillleri*, *Anadolu* 44 (2018), p. 37-52.

GOETHERT 1997 - K. Goethert, *Römische Lampen und Leuchter. Auswahlkatalog des Rheinischen Landesmuseums Trier*, Trier, 1997

GRANDJEAN 1988 - Y. Grandjean, *Recherches sur l'habitat thasien, Et. Thas. XII*, Paris, 1988.

GREENEWALT *et al.* 1987 - C. H. Greenewalt Jr., M. L. Rautman & N. D. Cahill, *The Sardis campaign of 1985*, BASOR Suppl. 25 (1985), p. 55-92.

HAKEN & MARSA 1974 - R. Haken & J. Marsa, *Lamps* in: J. Bouzek (ed.), *Anatolian Collection of Charles University [Kyme I]*, Prague, 1974, p. 165-167.

HANFMANN 1989 - G. M. A. Hanfmann, *On Lydian Sardis*, in: K. De Vries (ed.), *From Athens to Gordion. The Papers of a Memorial Symposium for Rodney Young*, Philadelphia, 1989, p. 99-107.

HOGARTH 1908 - D. G. Hogarth, *Excavations at Ephesus. The Archaic Artemisia*, London, 1908.

HØJTE 2010 - J. M. Højte, chap. *O-Lamps*, in: Lejpunskaia *et al.* (2010), vol. 1, p. 423-437, vol. 2, pls. 318-326.

HOWLAND 1958 - R. H. Howland, *Greek lamps and their survivals*, The Athenian Agora IV, Princeton, 1958.

HÜBINGER 1993 - U. Hübinger, *Die antiken lampen des akademischen Kunstmuseums der Universität Bonn*, Berlin, 1993.

- ICONOMU 1967 - C. Iconomu, *Opaițe greco-romane*, Constanța, 1967.
- ISLER 1978 - H. P. Isler, *Das archaische Nordtor und seine Umgebung im Heraion von Samos*, Samos IV, Bonn, 1978.
- KALAITZOGLOU 2008 - G. Kalaitzoglou, *Assesos. Ein geschlossener Befund südionischer Keramik aus der Heiligtum der Athena Assesia*, XII. Kleinfunde. A) Lampen, Milesische Forsch., Bd. 6, Mainz, 2008, p. 289-291.
- KASPAROV 2012 - A. K. Kasparov, *Nekotorye zamechaniya o faunisticheskikh ostatkakh iz poseleniya na o. Berezan*, in: Chistov 2012, p. 124-129.
- KASSAB-TEZGÖR & SEZER 1995 - D. Kassab-Tezgör, T. Sezer, *Catalogue des lampes en terre cuite du Musée Archéologique d'Istanbul*, T. 1. *Époques protohistorique, archaïque, classique et hellénistique*, Varia Anatolica VI. 1, Istanbul-Paris, 1995.
- KHUDIAK 1952 - M. M. Khudiak, *Raskopki soyatilnishch Nimfeya*, SovArkh 16 (1952), p. 232-281.
- KHUDYAK 1962 - M. M. Khudyak, *Iz istorii Nimfeya*, Leningrad, 1962.
- KINCH 1914 - K. F. Kinch, *Vroulia*, Berlin, 1914.
- KLEINER & MÜLLER WIENER 1972 - G. Kleiner, W. Müller-Wiener, *Grabung in Milet 1959*, IstMitt 22.
- KOPKE 1968 - G. Kopke, *Heraion von Samos : die Kampagnen 1961/65 im Südtemenos (8.-6. Jh.)*, AM 83 (1968), p. 250-281, Taf. 87-138, Beil. 8.
- KOROVINA 2002 - A. K. Korovina, *Hermonassa. Antichnyi gorod na Tamanskom poluostrove*, Moscow, 2002.
- KOSTRIN 1965 - K. V. Kostrin, *Issledovanie nefi iz srednevekovykh amfor, naidennykh bliz Stanitsy Proletarskoi*, SovArkh. 1, (1965), p. 291-293.
- KOSTRIN 1971 - K. V. Kostrin, *Issledovanie smolistogo osadka iz drevnykh amfor naidennykh pri raskopkakh Tanaisa*, SovArkh. 4, (1971), p. 264-265.
- KOZUB 1979 - Yu. I. Kozub, *Peredmistya Ol'vii*, Arkheologiya 29 (1979), p. 3-34.
- KRUTILOV *et al.* 2017 - V. V. Krutilov, A. I. Smirnov & D. V. Bondarenko, *Keramicheskii proizvodstvennyi kompleks Borisfena serediny VI veka do n.e.*, Trudy Gosudarstvennogo Ermitazha 88 (2017), p. 31-37.
- KRYZHITSKII *et al.* 1990 - S. D. Kryzhitskii (ed.), *Antichnye poseleniya Nizhnego Pobuzh'ya (Arkheologicheskaya karta)*, Kiev, 1990.
- LEHMANN 1962 - K. Lehmann, *Samothrace 4. 1. The Hall of votive gifts*, New York, 1962.
- LEJPUNSKAIA *et al.* 2010 - N. A. Lejpunskala, P. Guldager Bilde, J. M. Højte, V. V. Krapivina & S. D. Kryžickij, *The Lower City of Olbia (Sector NGS) in the 6th century BC to the 4th century AD*, Black Sea Studies 13, Aarhus, 2010.
- LE NORMAND 1828 - L.-S. Le Normand, *Manuel du chandelier, du cirier et du fabricant de cire à cacheter*, Paris, 1828.
- LEVINA 1987 - E. A. Levina, *Svetil'niki iz raskopok Tiry (konets VI-I do n. e.)*, in: *Novye issledovaniya po arkheologii Severnogo Prichernomor'ya*, Kiev, 1987, p. 108-118.
- MALYUKEVICH & PRISYAZHNYUK 2000 - A. E. Malyukevich, A. N. Prisyazhnyuk, *Lepnye svetil'niki pozdneskifskoi Mologi*, in: *Chobruchskii arkheologicheskii kompleks i drevnie kul'tury Podnestrov'ya (materialy polevogo seminara)*, Tiraspol', 2000, p. 154-162.

MARCHENKO 1988 - K. K. Marchenko, *Varvary v sostave naseleniya Berezani i Ol'vii vo vtoroi polovine VII - pervoi polovine I v. do n. e. po materialam lepnoi keramiki*, Leningrad, 1988.

MARCHENKO 1998 - K. K. Marchenko, *Varvary v sostave neseleniya Berezani i Ol'vii*, 1998.

MENZEL 1969 - H. Menzel, *Antike Lampen im Römisch-Germanischen Zentralmuseum zu Mainz*, RGZM Kat. 15, Mainz, 1969.

OBRUCHEV 1921 - V. A. Obruchev, *Mestorozhdennya nefiti i gazov Kerchenskogo poluostrova*, 5-8, 1921.

OKHOTNIKOV 1990 - S. B. Okhotnikov, *Nizhnee Podnestrov'e v VI-V vv. do n. e.*, Kiev, 1990.

Olbia 1964 - *Ol'vii. Temenos I Agora*, Moscow-Leningrad, 1964.

PANIONION UND MELIE 1967 - G. Kleiner, P. Hommel, W. Müller-Wiener, *Panionion und Melie*, JdI Suppl. 23, Berlin.

PARISINOU 1997 - E. Parisinou, *Artificial Illumination in Greek Cult Practice of the Archaic and the Classical periods: Mere Practical Necessity?*, *Thetis* 4 (1997), 95-108.

ROBINSON 1952 - D. M. Robinson, *Excavations at Olynthus XIV*, Oxford, 1952.

SEKERSKAYA 1989 - N. M. Sekerskaya, *Antichnyi Nikonii i ego okruza v VI-IV vv. do n. e.*, Kiev, 1989.

SELESNOW 1997 - W. Selesnow, *Milet 1994-1995*, *AA* 2 (1997), p. 137-143, fig. 25-31.

SHEIKO 2014 - I. N. Sheiko, *Miniatyurnye svetil'niki iz Ol'vii, Borisfena i poselenii khory*, *Bosporskie Issledovaniya* 30 (2014), p. 392-410.

SHEIKO 2016 - I. N. Sheiko, *Svitil'niki z Berezans'kikh kolektsii (materiali rozkopok V. V. Lapina i S. M. Mazarati)*, *Arkheologiya i davna istoriya Ukraini*, Kiiiev, 2016, fasc. 1 (18), p. 80-88.

SOLOVYOV 1995 - S. Solovyov, *Novye dannye o tipologii zhilishch Berezanskogo poseleniya v klassicheskuyu epokhu*, *SovArkh* 1, (1995), p. 121-132.

SOLOVYOV 1999 - S. L. Solovyov, *Ancient Berezan*, *Colloquia Pontica* 4, Leiden, 1999.

SOLOVYOV 2005 - S. L. Solovyov, *Borisfen - Berezan'. Nachalo antichnoj êpokhi v Severnom Prichernomor'e*, exhibition catalogue, St. Petersburg, 2005.

TECHNAU 1929 - W. Technau, *Griechische Keramik im samischen Heraion*, *AM* 54 (1929).

THOMAS 2015 - R. I. Thomas, *Naukratis: Lamps in terracotta and bronze*, in: A. Villing et al., *Naukratis: Greeks in Egypt*, London, 2015, p. 2-18.

Tocra I - J. Hayes, in *Excavations at Tocra 1963-1965. The Archaic Contexts I*, *BSA Suppl.* 4, 1966, p. 139-141, fig. 68, pl. 90.

Tocra II - J. Hayes, in *Excavations at Tocra 1963-1965. The Archaic Contexts II and Later Contexts*, *BSA Suppl.* 10, 1973, p. 64-65, fig. 26, pl. 32-33.

TOPOLEANU 2013 - F. Topoleanu, *Considerații preliminare privind lămpile grecești și elenistice de la Orgame / Argamum (com. Jurilovca, Jud. Tulcea)*, *Peuce*, S.N. 11, (2013), p. 43-65.

TOPOLEANU & CROITORU 2015 - F. Topoleanu, C. Croitoru, *Lămpile antice din colectia Muzeului Brăilei « Carol I »*, Brăila, 2015.

USPENSKII 1952 - V. A. Uspenskii, *Issledovanie drevnei amfory s neft'yu naidennoi v Tiritake*, MIA 25, 1952, p. 415-421.

UTILI 1999 - F. Utili, *Die archaische Nekropole von Assos*, Asia Minor Studien, 31, Bonn, 1999.

VREKAJ 2004 - B. Vrekaj, *L'éclairage à Apollonia. Les lampes et les autres alternatives*, in : P. Cabanes & J. Lamboley (eds.), *L'Illyrie méridionale et l'Épire dans l'antiquité IV*. Actes de l'IV^e Colloque international de Grenoble (10-12 oct. 2002), Paris, 2004, p. 269-278.

WALDHAUER 1914 - O. Waldhauer, *Imperatorskii Ermitazh. Antichnye glinyanye Svetil'niki*, Sankt-Peterburg, 1914.

WALTER 1957 - H. Walter, *Frühe samische Gefässe und ihre Fundlage I*, AM 72 (1957), p. 35-51, Beil. 67-75.

ZABELINA 1987 - E. A. Zabelina, *Svetilniki iz raskopok Tiry (konets VI-I v. do n.e.)*, in: *Novye issledovaniya po arkhologii Severnogo Prichernomor'ya*, Kiev, 1987, p. 109-118.

ZABELINA 1992 - V. S. Zabelina, *Antichnye glinyanye svetil'niki iz Pantikapeya*, in: *Arkheologiya i iskusstvo Bospora, Soobshcheniya Gosudarstvennogo Muzeya Izobrazitel'nykh Iskusstv imeni A. S. Pushkina* 10 (1992), p. 298-328.

ZAVOIKIN & ZHURAVLEV 2005 - A. Zavoikin, D. Zhuravlev, *Lamps from the sanctuary of Eleusinian Goddesses in Kimmerian Bosporus*, in: L. Chrzanovski (ed.), *Lychnological Acts 1*, Actes du 1^{er} Congrès international d'études sur le luminaire antique, Nyon-Genève, 2003, = *Monographies Instrumentum* 31, Montagnac, 2005, p. 309-316.

ZHURAVLEV 1983 - O. P. Zhuravlev, *Zhivotnovodstvo okhota i landshaftnye osobennosti antichnogo Ol'viiskogo gosudarstva (po kostnym ostatkam)*, *Morfologicheskie osobennosti pozvonochnykh Ukrainy*, Kiev, 1983.

ZHURAVLEV & KHRSHANOVSKI 2003 - D. V. Zhuravlev, L. Khrshanovski, *Svetil'niki s ostrova Berezan' v sobranii Gosudarstvennogo Istoricheskogo Muzeya (Moskva)*, *Arkheologiya (UA= Ukraine)* 3, (2003), p. 15-21.

ZHURAVLEV & ZAVOIKIN 2004 - D. V. Zhuravlev, A. A. Zavoikin, *Svetil'niki iz svyatilnishcha elevsinsikh boginh' «Beregovoi 4»*, in: *Bosporskii Fenomen: problemy khronologii i datirovki pamyatnikov 1*, Sankt-Peterburg, 2004, p. 192-199.

ZHURAVLEV & ZHURAVLEVA 2005 - D. Zhuravlev N. Zhuravleva, *Light equipment in the Early Bosporan Kingdom (6th-5th centuries BC)*, in: L. Chrzanovski (ed.), *Lychnological Acts 1*, Actes du 1^{er} Congrès international d'études sur le luminaire antique, Nyon-Genève, 2003, = *Monographies Instrumentum* 31, Montagnac, 2005, p. 313-316.

ZHURAVLEV et al. 1990 - O. P. Zhuravlev, E. P. Markova & L. V. Sychova, *K istorii zhivotnovodstva Ol'viiskoi sel'skoi okrugi*, in : *Kryzhitskii et al.* 1990, p. 98-113.

ZHURAVLEV et al. 2005 - D. V. Zhuravlev, M. I. Zolotarev, A. A. Kobzeva, *Svetil'niki iz severo-vostochnogo raiona Khersonesa: pozdnearkhaicheskoe, klassicheskoe i ellinisticheskoe vremya*, *Khersonesskii Sbornik* 14, (2005), p. 129-140.

ZHURAVLEV et al. 2007 - D. V. Zhuravlev, N. V. Bykovskaya, A. L. Zheltikova, *Iz sobraniya Kerchenskogo Istoriko-Kul'turnogo Zapovednika. Kolleksiya Svetil'nikov T. 1. Svetil'niki VI-pervoi poloviny III v. do n. e.*, Kiev, 2007

CROSS-REFERENCES TO THE ILLUSTRATIONS

B. 252	Fig. 25 ; Pl. 33
B. 368	Fig. 28 ; Pl. 38
B. 385	Fig. 10 ; Pl. 15
B. 479	Fig. 29 ; Pl. 40
B. 62-50	Fig. 18 ; Pl. 25
B. 62-51	Fig. 14 ; Pl. 21
B. 63-326	[-] ; [Pl. 34]
B. 63-152	Fig. 17 ; Pl. 24
B. 63-153	Fig. 17 ; Pl. 24
B. 63-154	Fig. 7 ; Pl. 13
B. 63-155	Fig. 4 ; Pl. 10
B. 63-234	[-] ; Pl. 39
B. 63-326	[-] ; Pl. 34
B. 64-105	[-] ; Pl. 36
B. 64-106	Fig. 1 ; Pl. 7
B. 64-208	Fig. 23 ; Pl. 31
B. 65-107	[-] ; [Pl. 30]
B. 65-118	Fig. 27 ; Pl. 37
B. 65-277	[-] ; Pl. 32
B. 65-375	[-] ; Pl. 34
B. 66-144	[<i>non vidi</i>] ; Pl. 27
B. 66-158	[-] ; Pl. 35
B. 67-104	Fig. 20 ; Pl. 28
B. 67-110	Fig. 20 ; Pl. 28
B. 67-159	Fig. 23 ; Pl. 33
B. 67-163	Fig. 1 ; Pl. 7
B. 68-104	Fig. 23 ; Pl. 33
B. 69-109	Fig. 19 ; Pl. 26
B. 69-120	Fig. 15 ; Pl. 22
B. 69-121	Fig. 12 ; Pl. 19
B. 69-183	Fig. 11 ; Pl. 17
B. 69-235	Fig. 29 ; Pl. 40
B. 69-237	Fig. 14 ; Pl. 21
B. 69-242	(-) ; Pl. 11
B. 69-244	Fig. 1 ; Pl. 7
B. 69-246	Fig. 18 ; Pl. 25
B. 70-124	Fig. 14 ; Pl. 21
B. 70-204	Fig. 7 ; Pl. 13

B. 70-206	Fig. 1 ; Pl. 7
B. 71-116	Fig. 19 ; Pl. 26
B. 71-117	Fig. 7 ; Pl. 13
B. 71-118	Fig. 16 ; Pl. 23
B. 71-120	Fig. 27 ; Pl. 36
B. 71-121	Fig. 7 ; Pl. 13
B. 71-253	Fig. 2 ; Pl. 7
B. 71-254	Fig. 2 ; Pl. 7
B. 71-256	Fig. 8 ; Pl.13
B. 72-110	Fig. 16 ; Pl. 23
B. 72-111	Fig. 8 ; Pl. 14
B. 72-112	Fig. 28 ; Pl. 38
B. 72-113	Fig. 8 ; Pl. 14
B. 72-115	Fig. 5 ; Pl. 11
B. 72-116	Fig. 5 ; Pl. 11
B. 72-199	Fig. 23 ; Pl. 31
B. 73-31	(-) ; Pl. 28
B. 73-185	Fig. 5 ; Pl. 11
B. 73-200	Fig. 14 ; Pl. 21
B. 73-201	Fig. 12 ; Pl. 19
B. 73-202	Fig. 8 ; Pl. 14
B. 73-204	Fig. 27 ; Pl. 36
B. 73-265	Fig. 2 ; Pl. 8
B. 73-320	Fig. 11 ; Pl. 18
B. 74-84	Fig. 5 ; Pl. 12
B. 74-85	Fig. 19 ; Pl. 26
B. 74-89	Fig. 22 ; Pl. 30
B. 74-90	Fig. 27 ; Pl. 37
B. 74-96	Fig. 12 ; Pl. 19
B. 74-224	Fig. 29 ; Pl. 40
B. 74-231	Fig. 19 ; Pl. 26
B. 74-232	Fig. 13 ; Pl. 20
B. 75-93	Fig. 22 ; Pl. 30
B. 75-95	Fig. 22 ; Pl. 30
B. 75-135	Fig. 15 ; Pl. 22
B. 75-138	Fig. 9 ; Pl. 14
B. 75-139	Fig. 15 ; Pl. 22
B. 76-106	Fig. 11 ; Pl. 18
B. 76-108	Fig. 10 ; Pl. 16
B. 76-120	Fig. 12 ; Pl. 19
B. 76-124	Fig. 9 ; Pl. 14
B. 76-131	Fig. 19 ; Pl. 26

B. 76-138	Fig. 13 ; Pl. 20
B. 76-140	Fig. 16 ; Pl. 23
B. 76-270	Fig. 24 ; Pl. 35
B. 77-68	Fig. 15 ; Pl. 22
B. 77-74	Fig. 20 ; Pl. 28
B. 77-76	Fig. 13 ; Pl. 20
B. 77-77	Fig. 11 ; Pl. 17
B. 77-175	Fig. 24 ; [-]
B. 77-181	Fig. 27 ; [-]
B. 77-208	Fig. 2 ; Pl. 8
B. 77-209	Fig. 2 ; Pl. 8
B. 77-210	Fig. 9 ; Pl. 15
B. 77-211	Fig. 18 ; Pl. 25
B. 78-77	Fig. 4 ; Pl. 10
B. 78-79	Fig. 3 ; Pl. 8
B. 79-57	Fig. 13 ; Pl. 20
B. 79-58	Fig. 20 ; Pl. 28
B. 79-74	Fig. 27 ; Pl. 37
B. 79-155	Fig. 13 ; Pl. 20
B. 82-75	Fig. 9 ; Pl. 15
B. 82-76	Fig. 21 ; Pl. 29
B. 82-158	Fig. 26 ; Pl. 36
B. 82-159	Fig. 27 ; Pl. 37
B. 82-162	Fig. 10 ; Pl. 16
B. 82-169	Fig. 26 ; Pl. 36
B. 82-170	Fig. 26 ; Pl. 37
B. 82-177	Fig. 28 ; Pl. 38
B. 82-184	Fig. 9 ; Pl. 15
B. 82-185	(-) ; Pl. 22
B. 83-112	Fig. 25 ; Pl. 33
B. 83-285	Fig. 17 ; Pl. 24
B. 84-91	Fig. 5 ; Pl. 12
B. 84-92	Fig. 16 ; Pl. 23
B. 84-93	Fig. 6 ; Pl. 12
B. 84-94	Fig. 16 ; Pl. 23
B. 84-95	Fig. 12 ; Pl. 19
B. 84-96	Fig. 6 ; Pl. 12
B. 84-203	Fig. 3 ; Pl. 9
B. 84-204	Fig. 4 ; Pl. 10
B. 85-74	Fig. 3 ; Pl. 9
B. 85-146	Fig. 21 ; Pl. 29
B. 85-147	Fig. 25 ; Pl. 33

B. 86-49	Fig. 17 ; Pl. 24
B. 86-50	Fig. 11 ; Pl. 18
B. 86-51	Fig. 26 ; Pl. 37
B. 87-36	Fig. 21 ; Pl. 29
B. 87-37	Fig. 15 ; Pl. 22
B. 87-38	Fig. 4 ; Pl. 10
B. 87-99	(-) ; Pl. 16
B. 87-100	(-) ; Pl. 27
B. 87-106	(-) ; Pl. 39
B. 88-44	Fig. 29 ; Pl. 39
B. 89-98	Fig. 6 ; Pl. 12
B. 89.99	Fig. 6 ; Pl. 12
B. 89-100	Fig. 10 ; Pl. 15
B. 89-101	Fig. 3 ; Pl. 9
B. 89-102	Fig. 10 ; Pl. 15
B. 89-103	Fig. 14 ; Pl. 21
B. 89-149	Fig. 25 ; Pl. 32
B. 90-102	Fig. 25 ; Pl. 32
B. 91-79	(-) ; Pl. 18
B. 91-107	Fig. 22 ; Pl. 30
B. 91-108	(-) ; Pl. 30
B. 91-167	(<i>non vidi</i>) ; Pl. 30

FIGURES

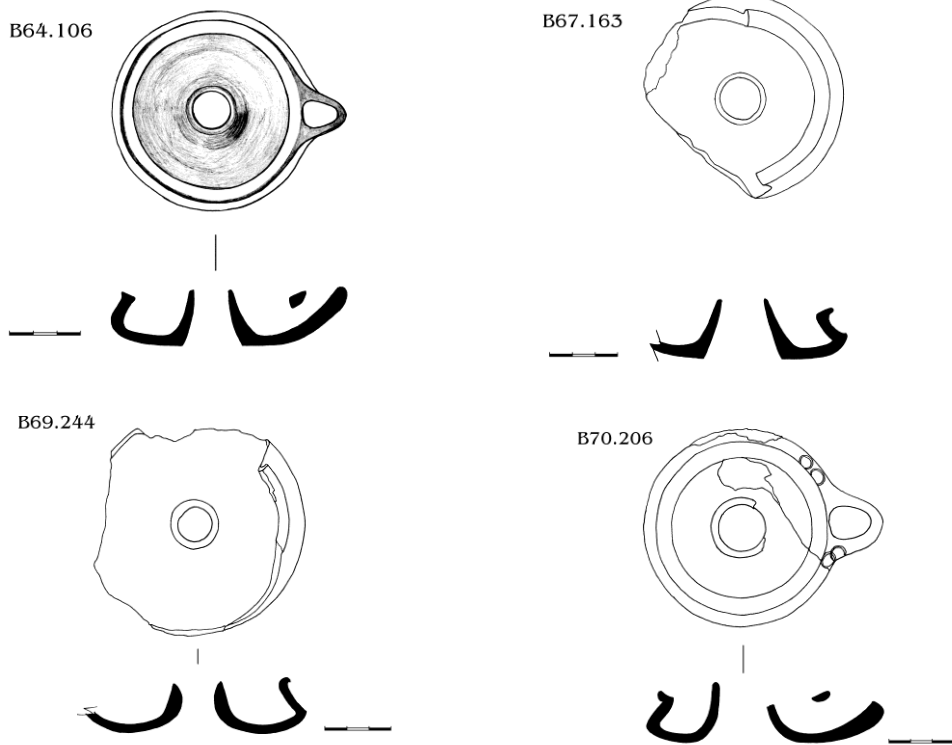

Fig. 1

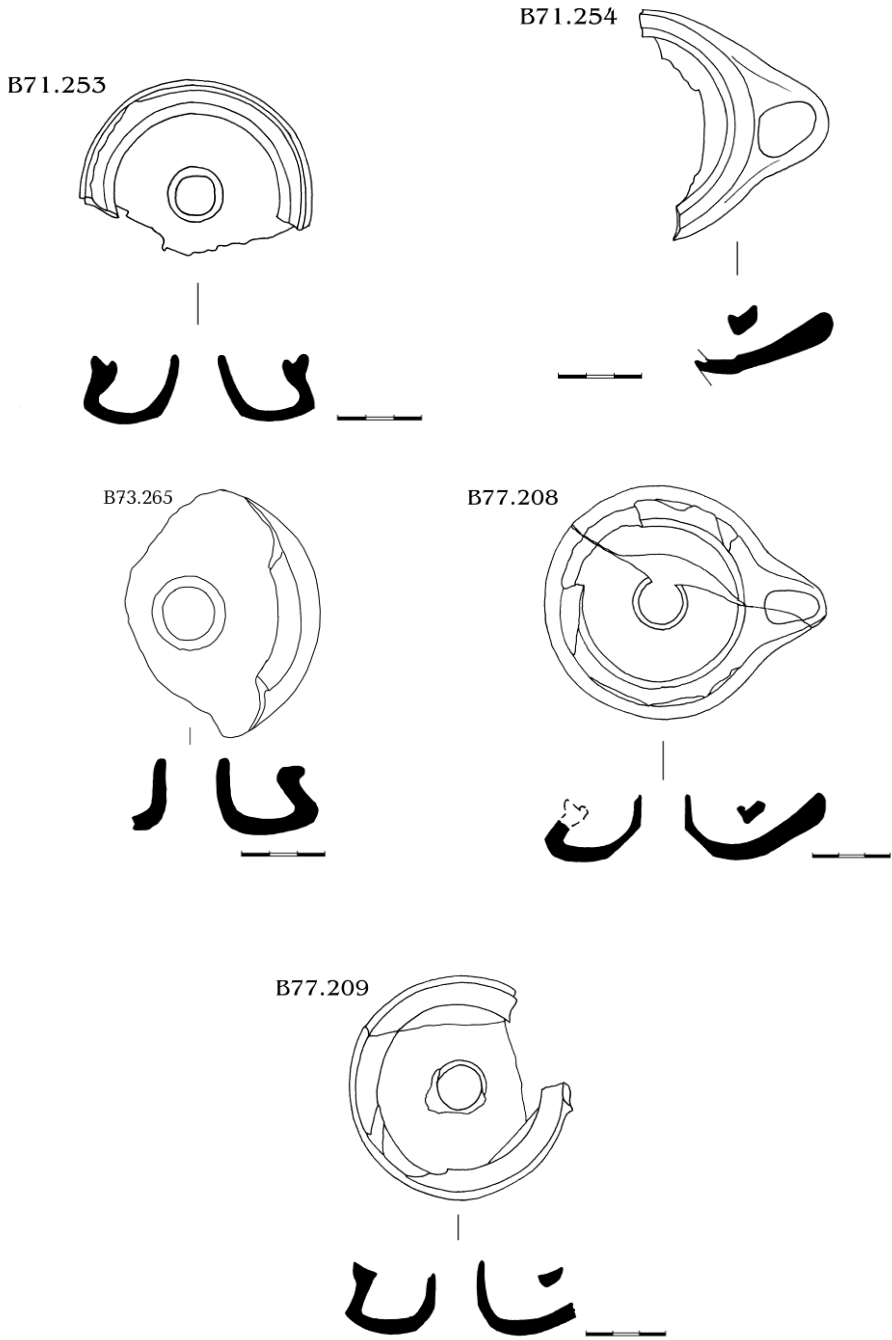
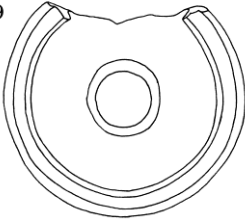
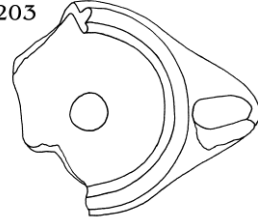

Fig. 2

B78.79



B84.203



B85.74

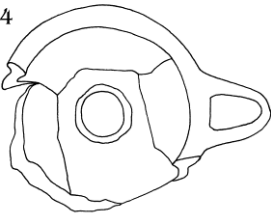

B89.101

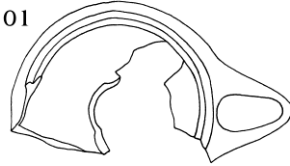

Fig. 3

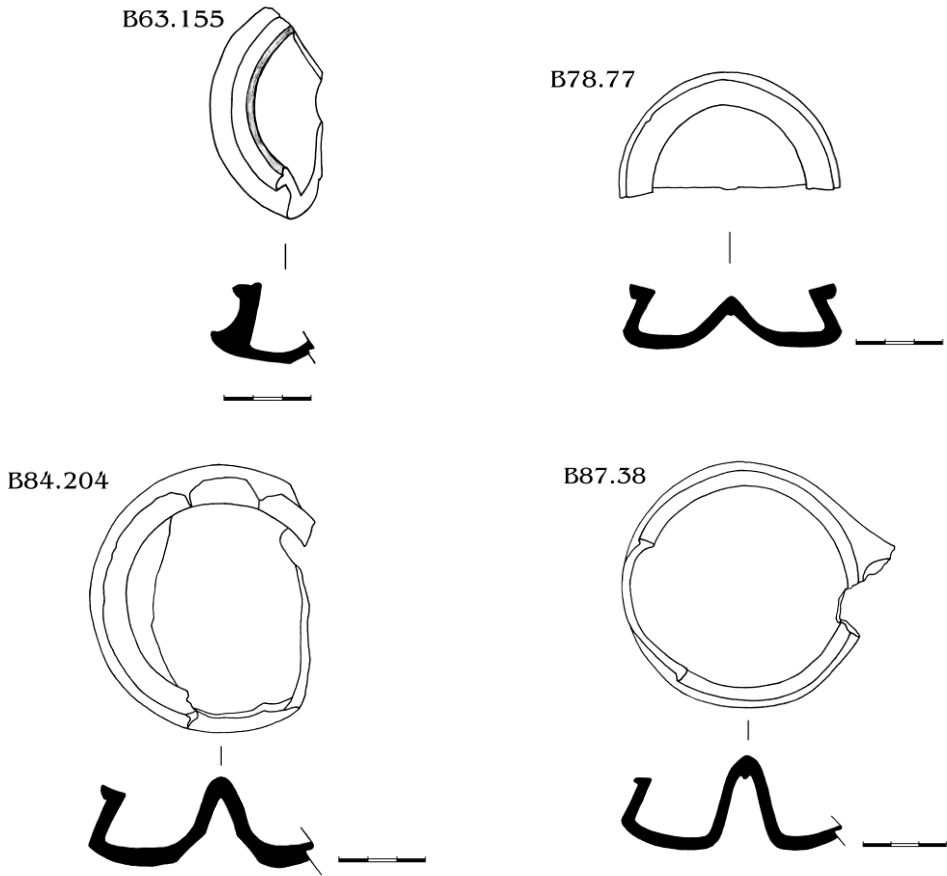
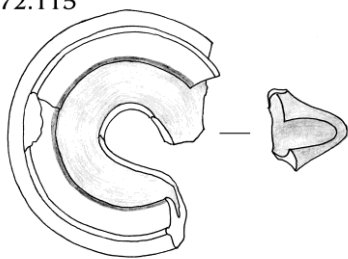

Fig. 4

B72.115



B72.116



B73.185

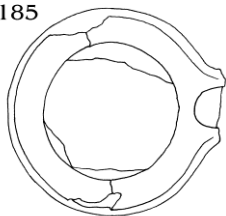

B74.84

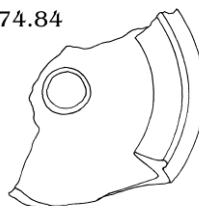

B84.91

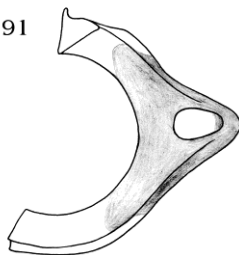

Fig. 5

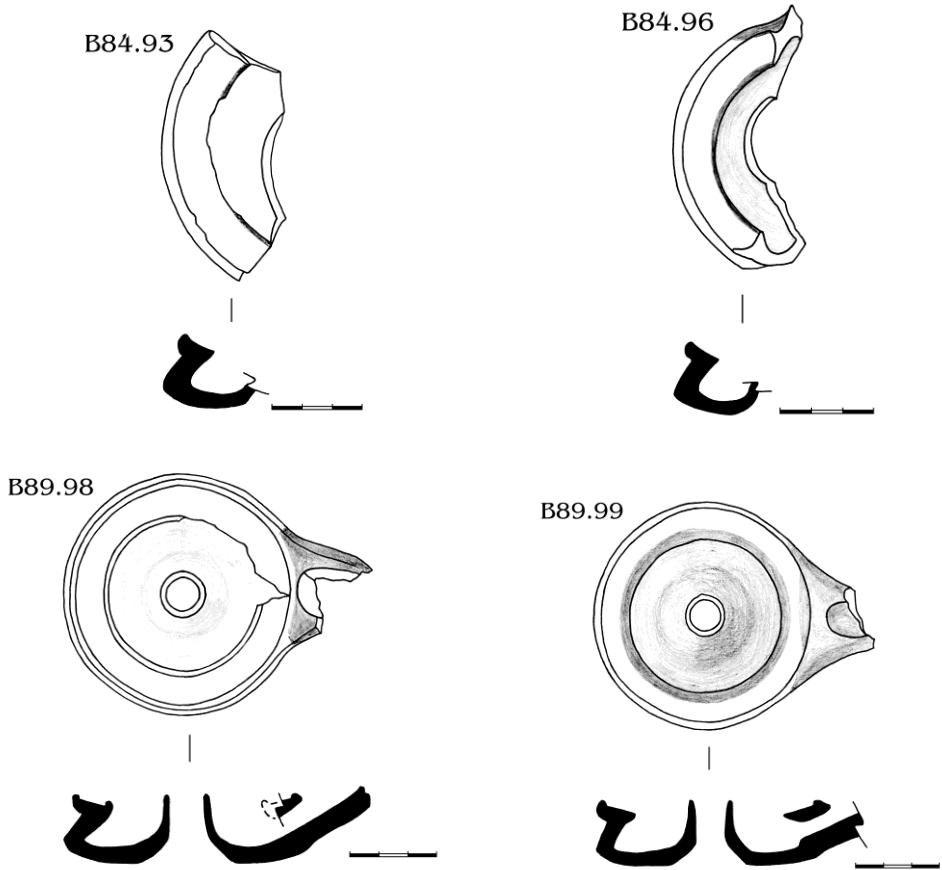

Fig. 6

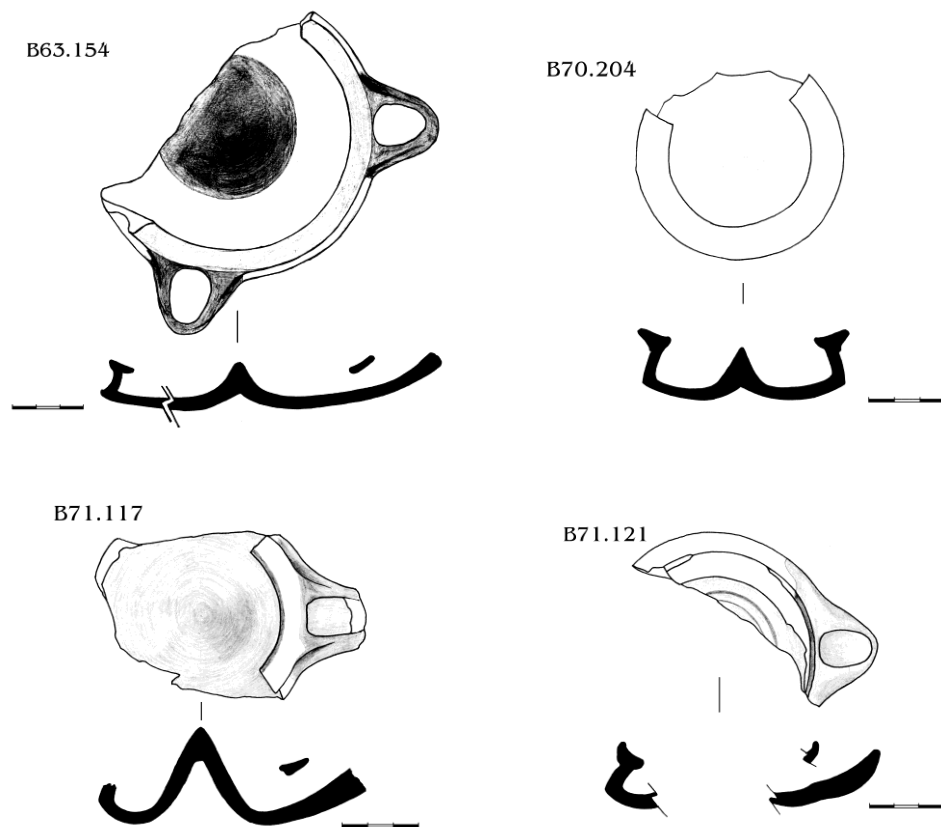

Fig. 7

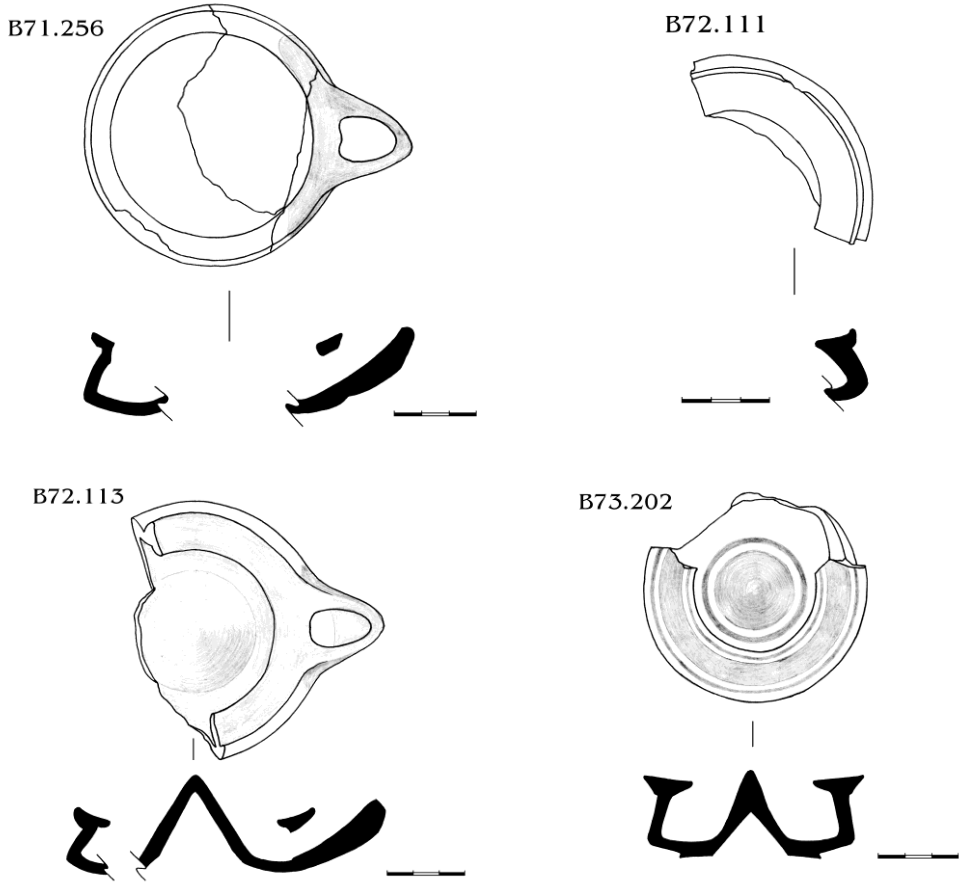

Fig. 8

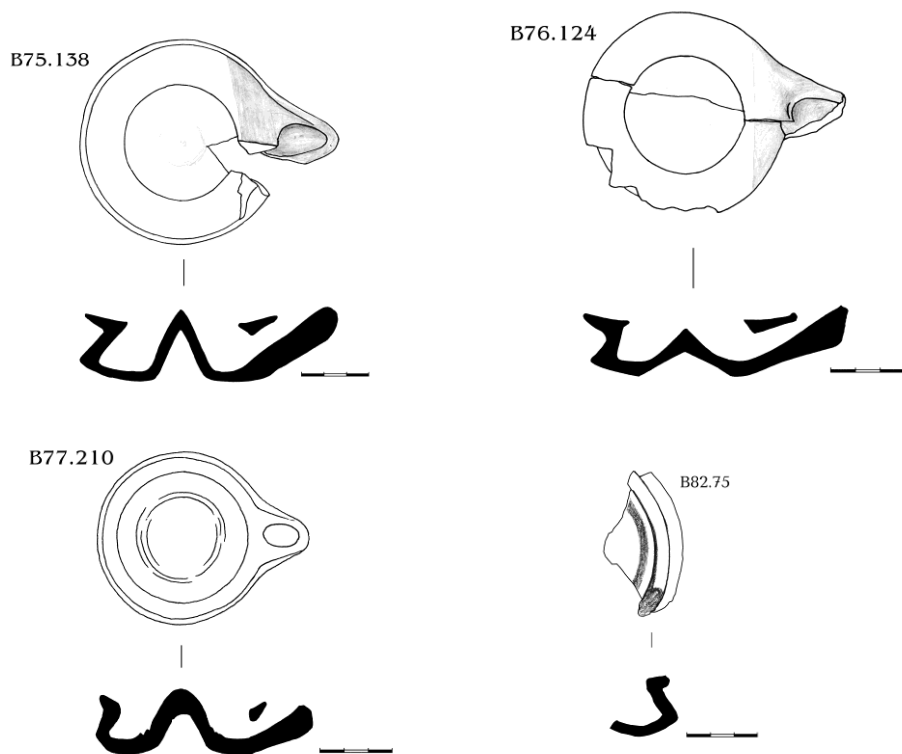
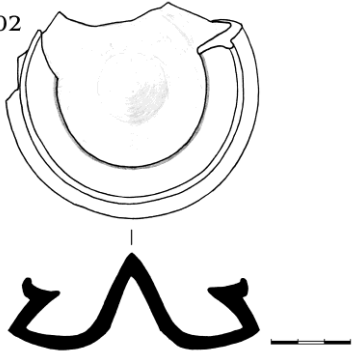
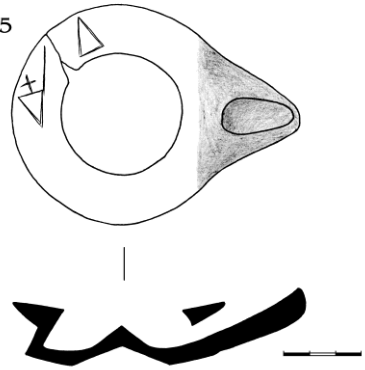

Fig. 9

B89.102



B385



B76.108

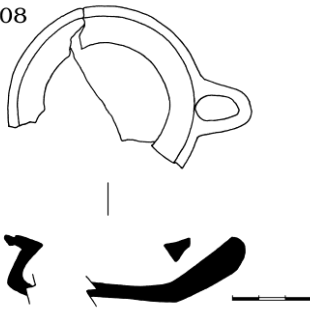

B82.162

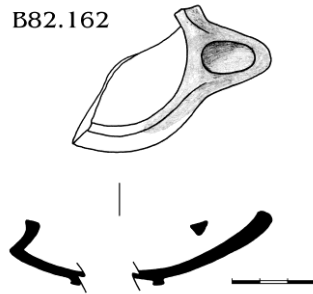

B89.100

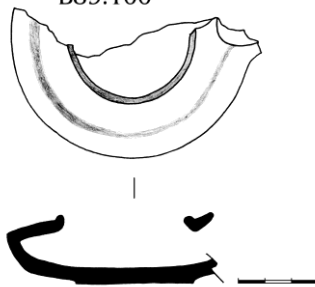

Fig. 10

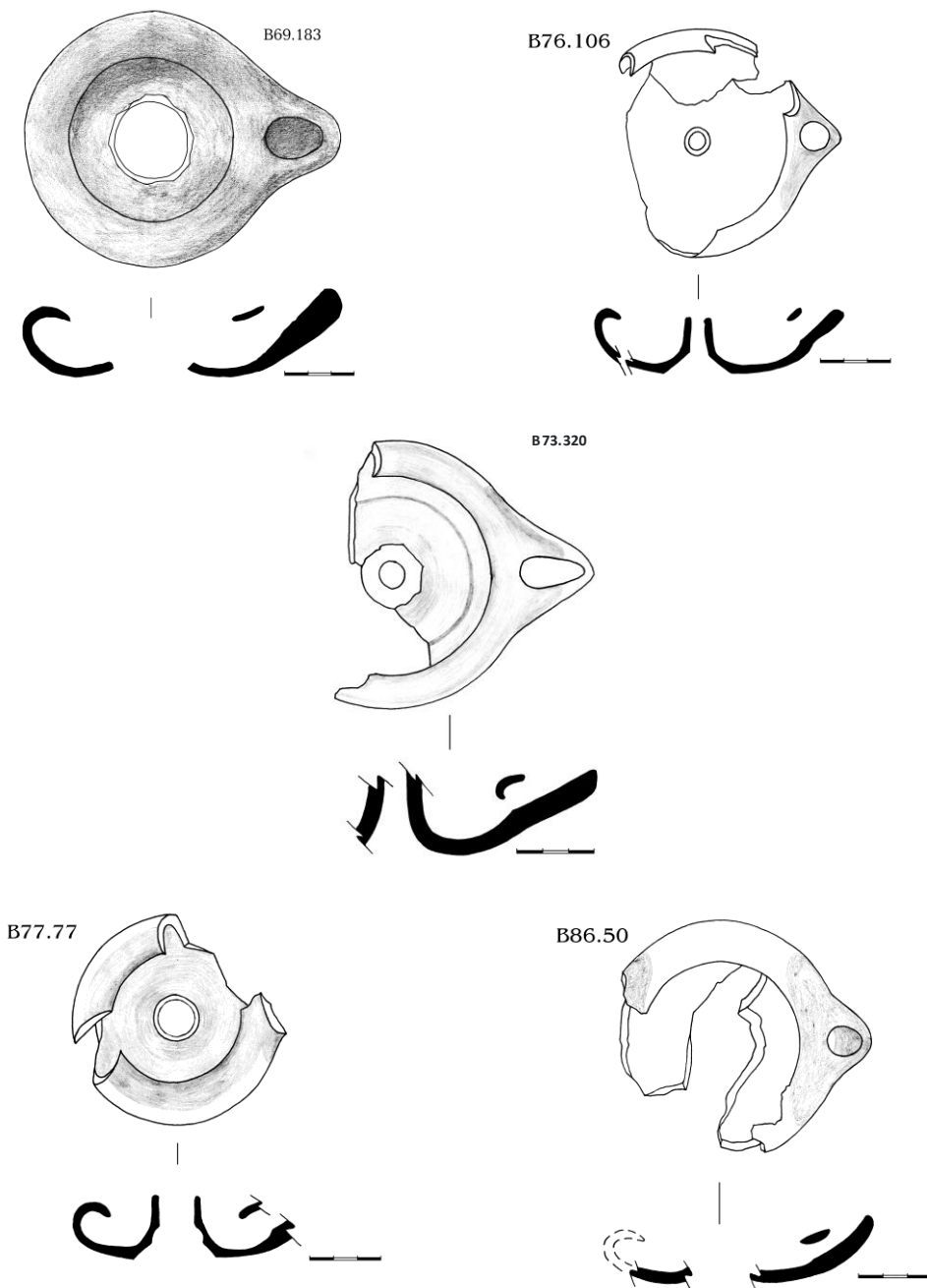
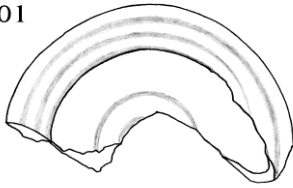
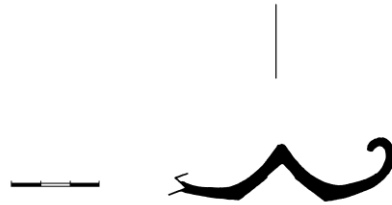
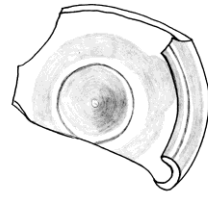

Fig. 11

B73.201



B69.121



B74.96

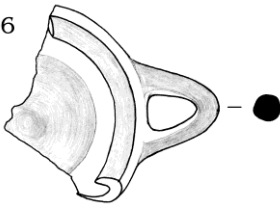

B76.120

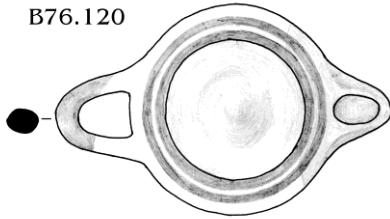

B84.95

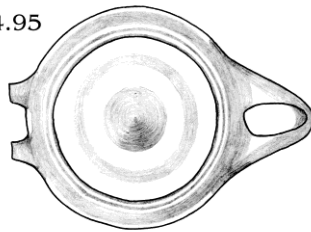
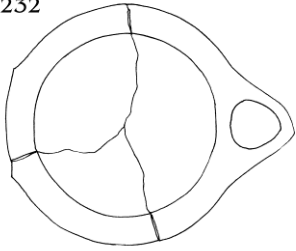

Fig. 12

B74.232



B77.76



B76.138

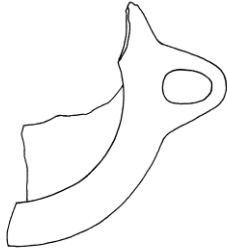

B79.57

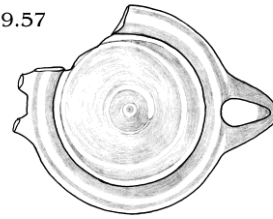

B79.155

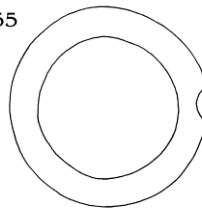
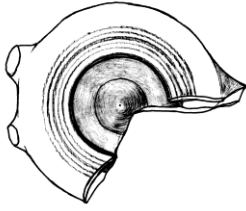

Fig. 13

B62.51



B69.237



B70.124



B73.200

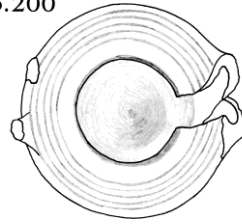

B89.103

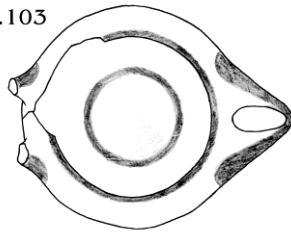

Fig. 14

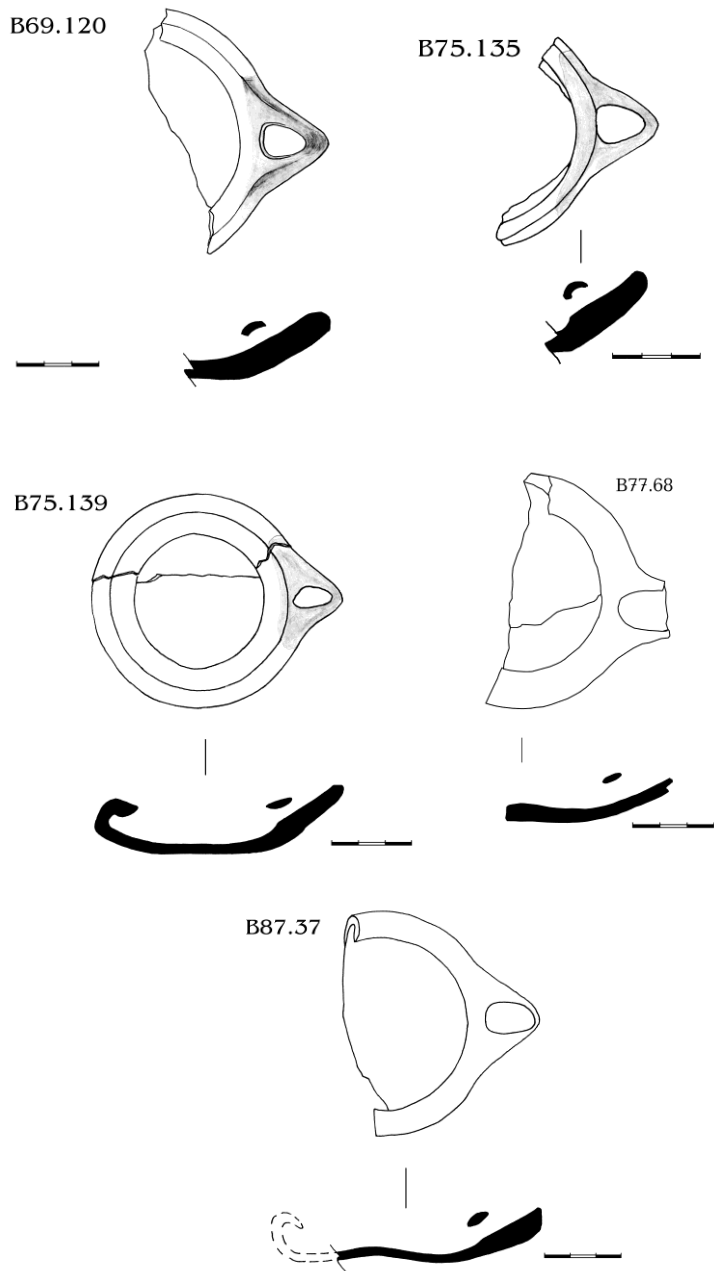
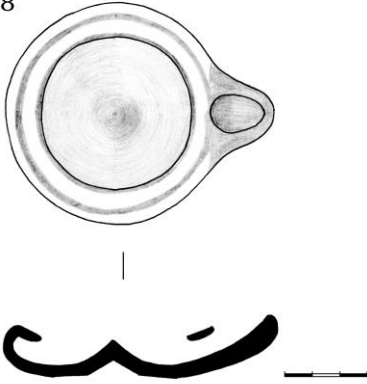
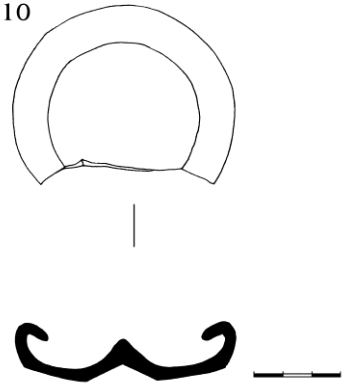

Fig. 15

B71.118



B72.110



B76.140

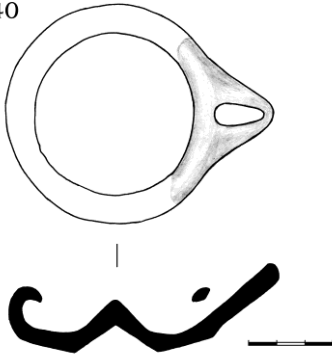

B84.92

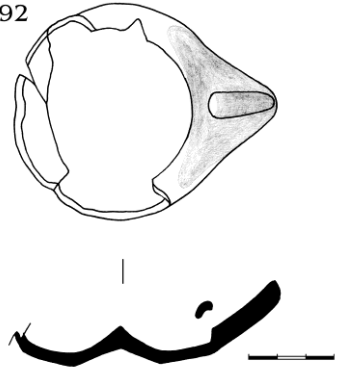

B84.94

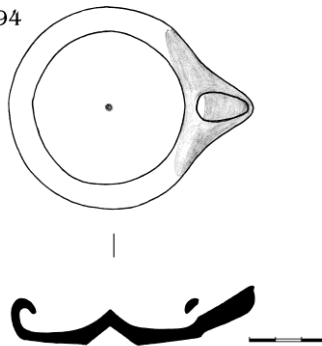
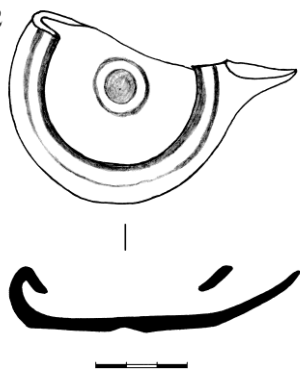
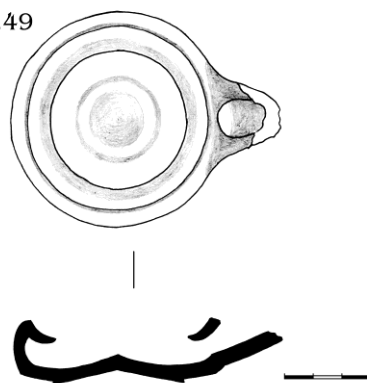

Fig. 16

B63.152



B86.49



B63.153

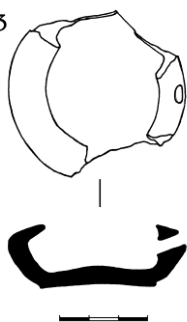

B83.285

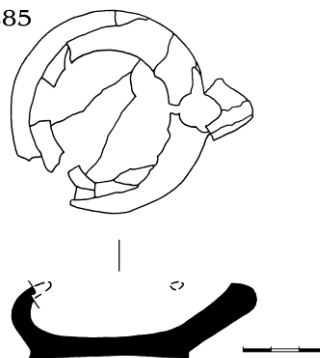
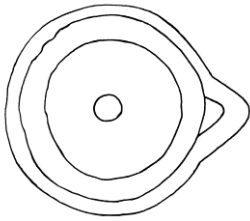
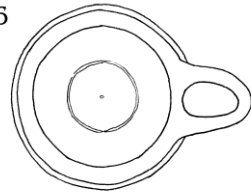

Fig. 17

B62.50



B69.246



B77.211

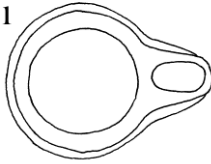

Fig. 18

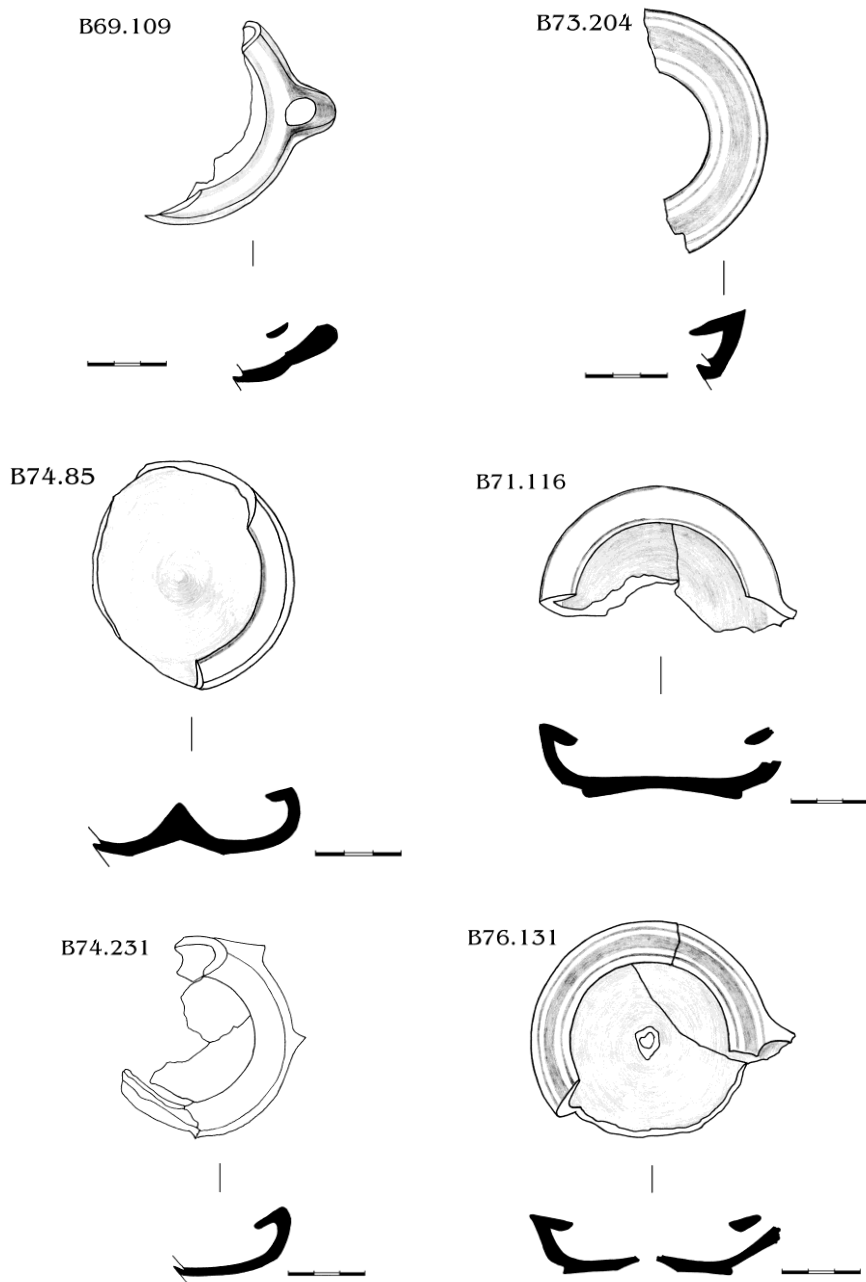

Fig. 19

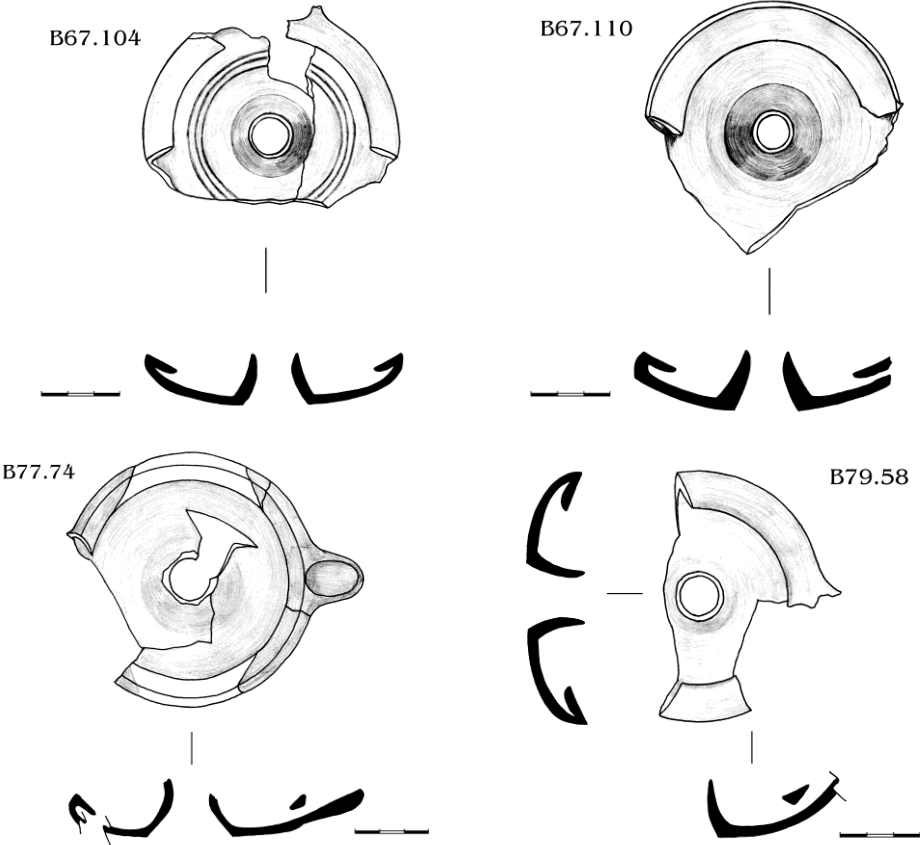

Fig. 20

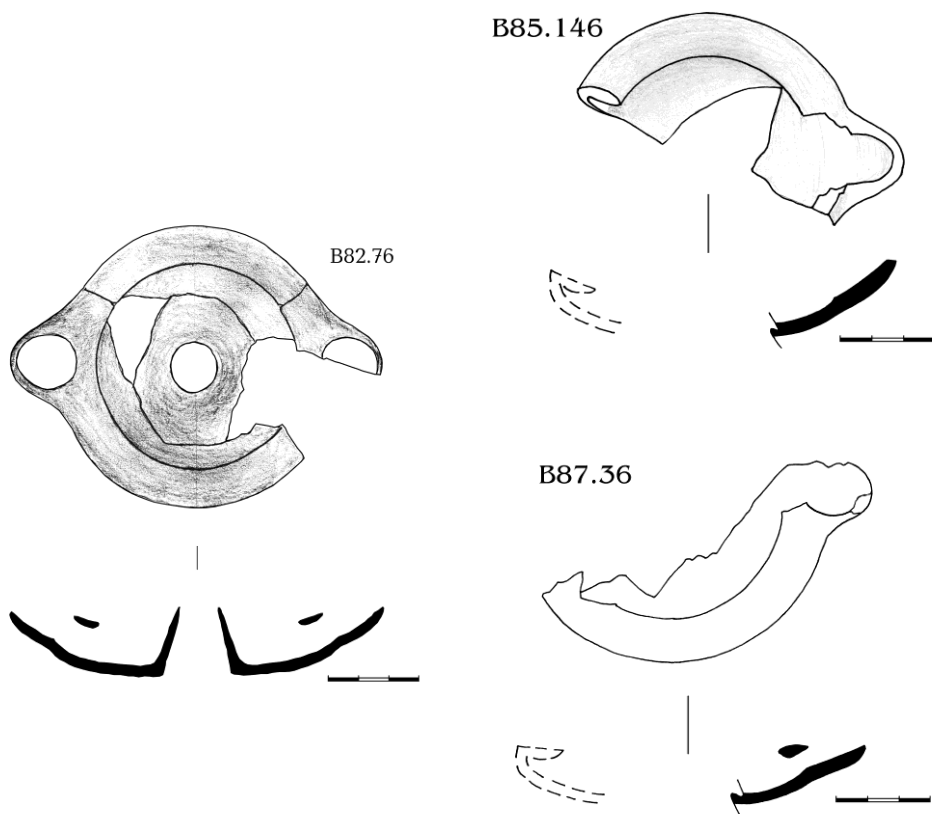

Fig. 21

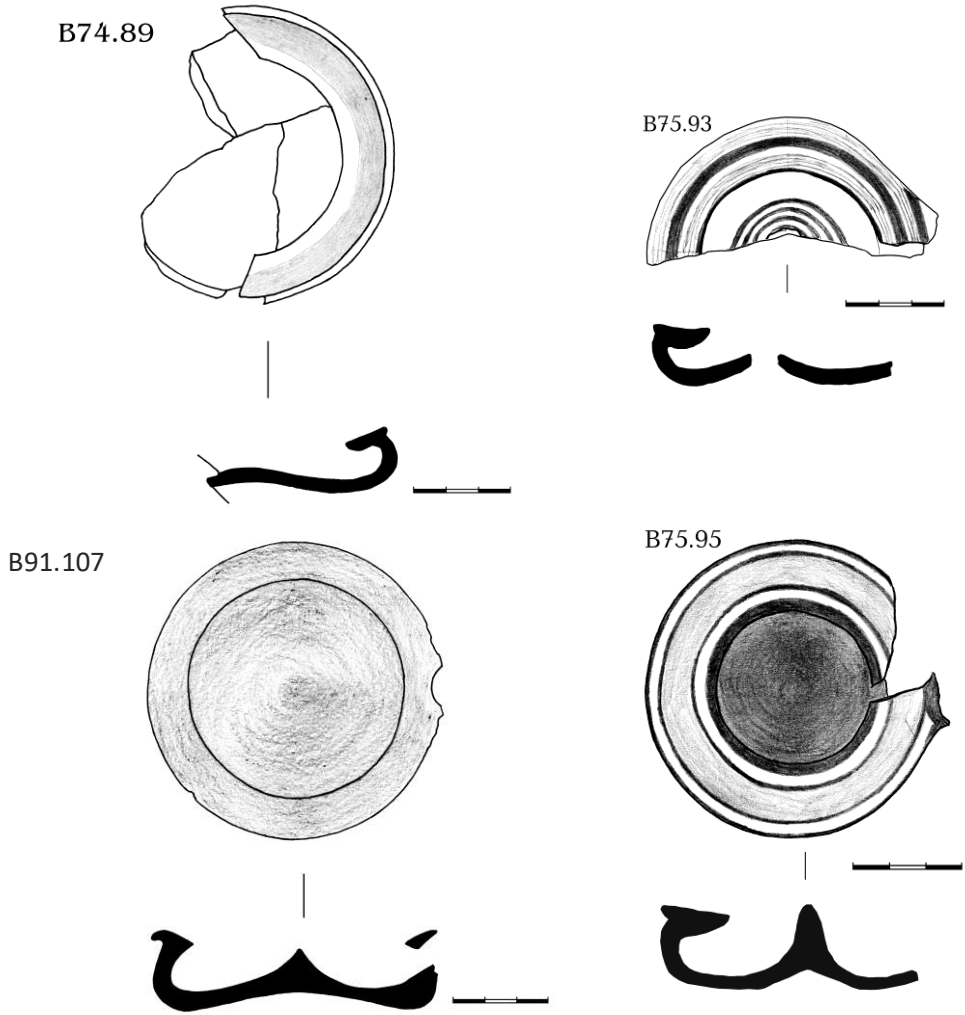

Fig. 22

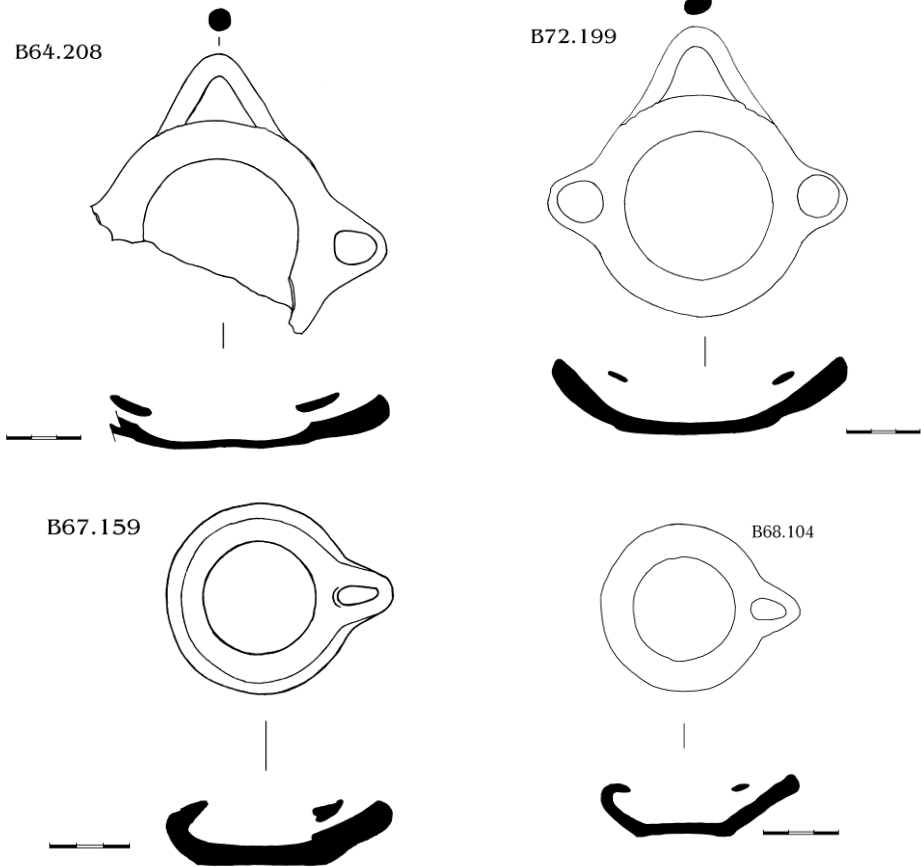
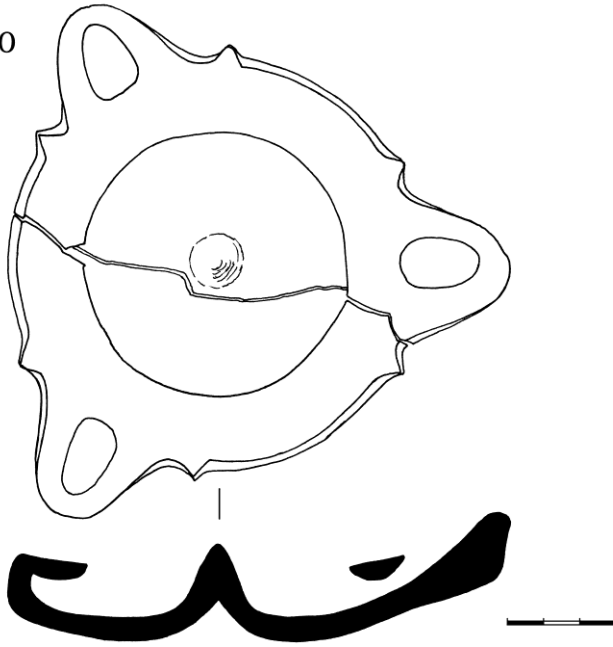

Fig. 23

B76.270



B77.175

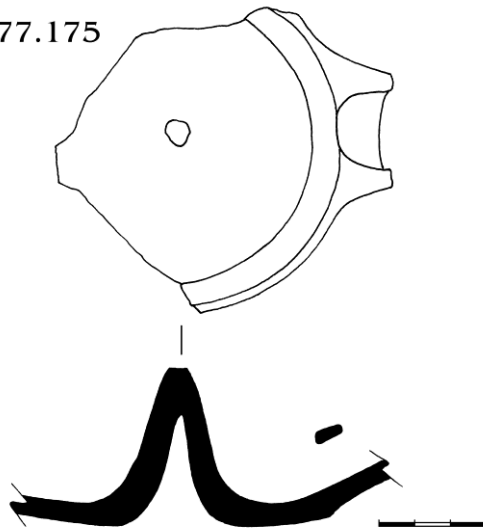

Fig. 24

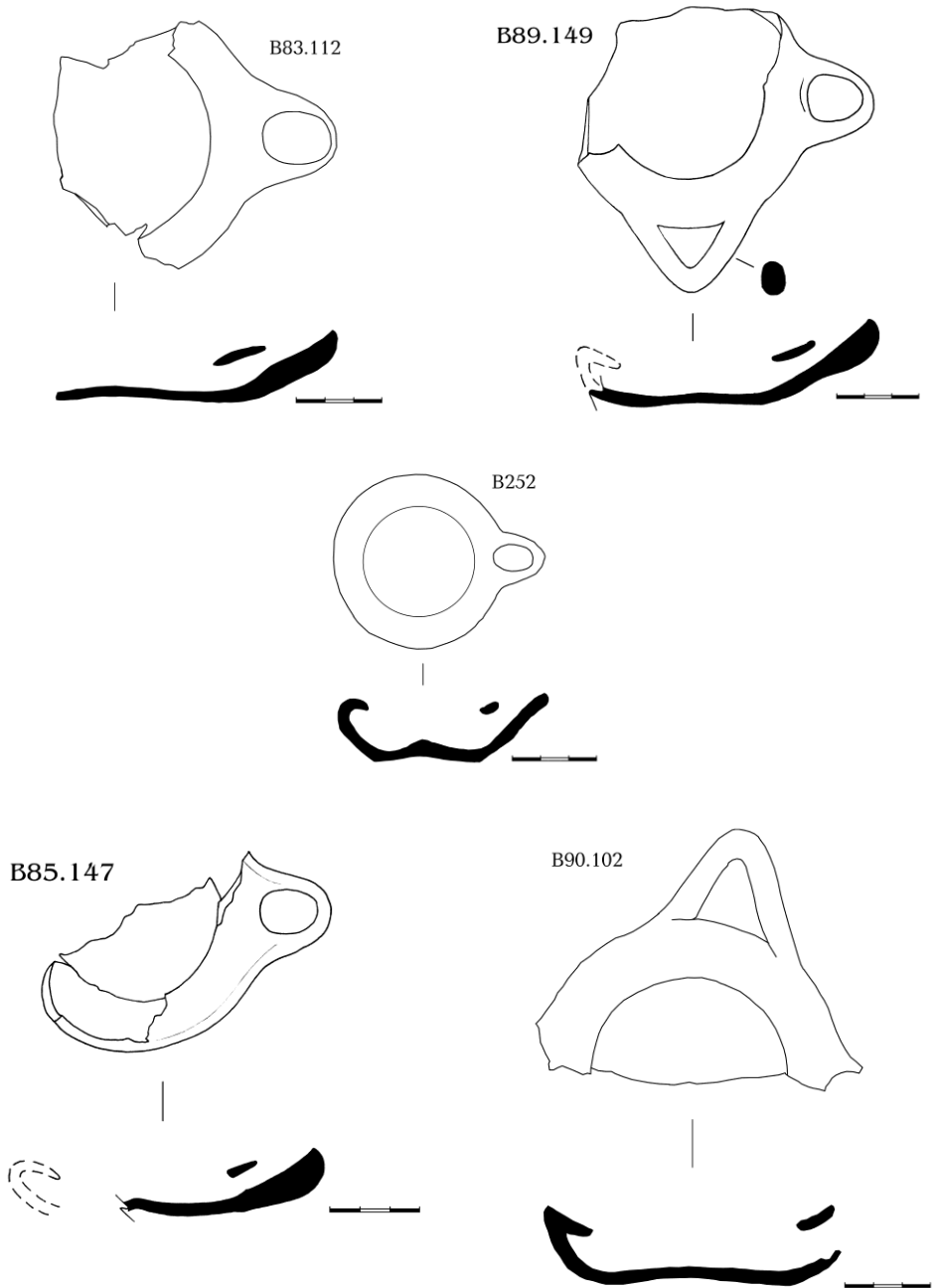
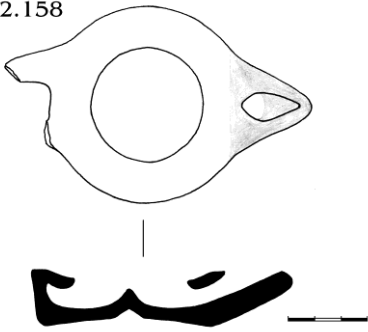
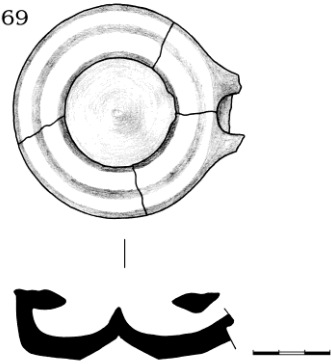

Fig. 25

B82.158



B82.169



B82.170

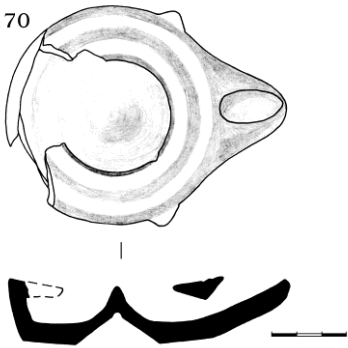

B86.51

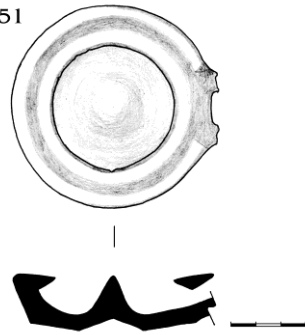

Fig. 26

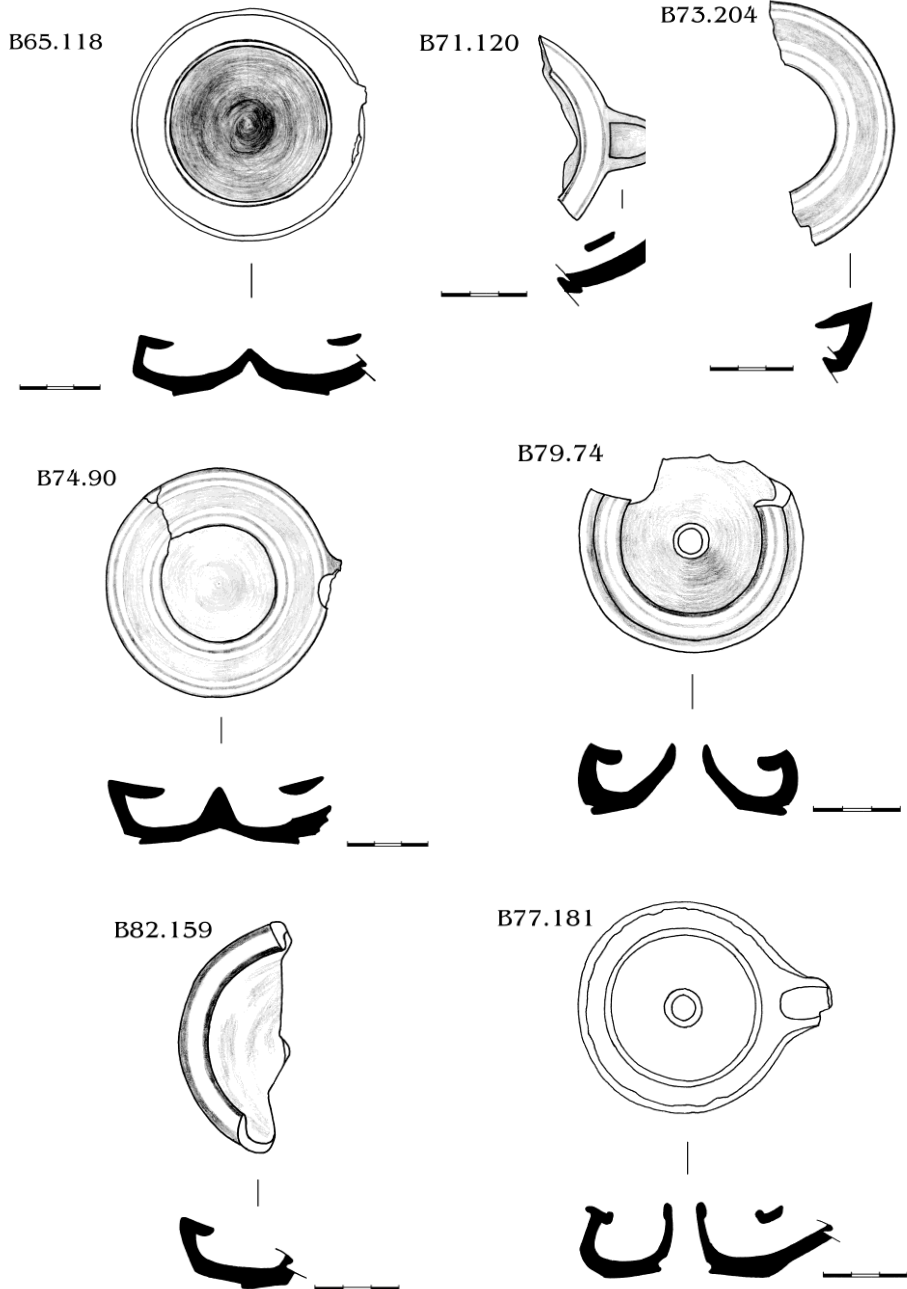
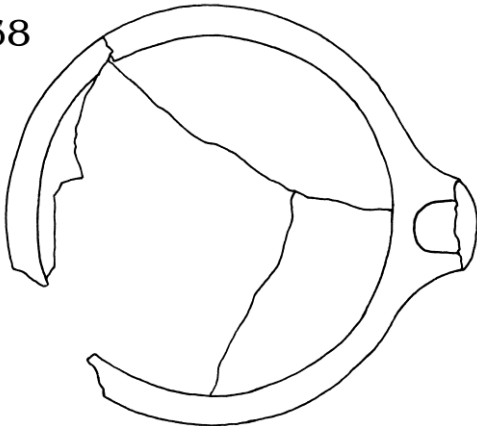
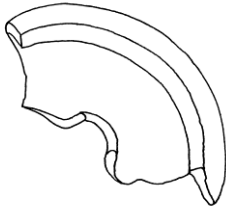

Fig. 27

B368



B72.112



B82.177

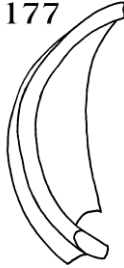

Fig. 28

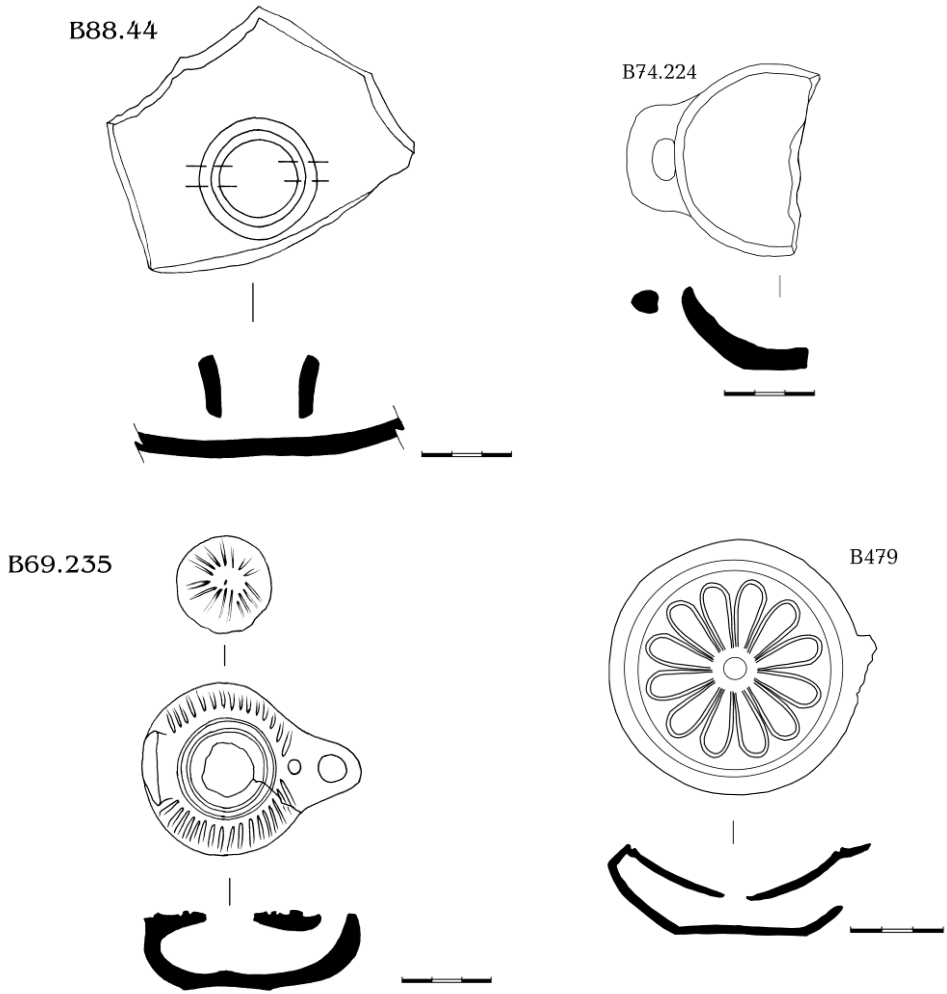

Fig. 29

PLATES



a



b



c

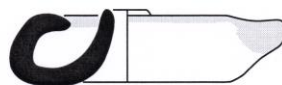

d

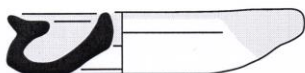

e



f



g



h

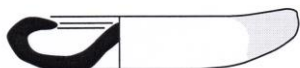

i



j

Plate 1



(a) Berezan B. 77-208



(b) Berezan B. 70-206



(c) Berezan B. 67-163



(d) Berezan B. 77-210



(e) Histria, Lambrino exc.

Plate 2



a) Berezan B. 89-102



(d) Thasos, passim



b) Berezan B. 75-138



(e) Berezan B. 77-74



c) Kyme, passim

Plate 3



(a) Berezan B. 76-120



(c) Berezan B. 91-79

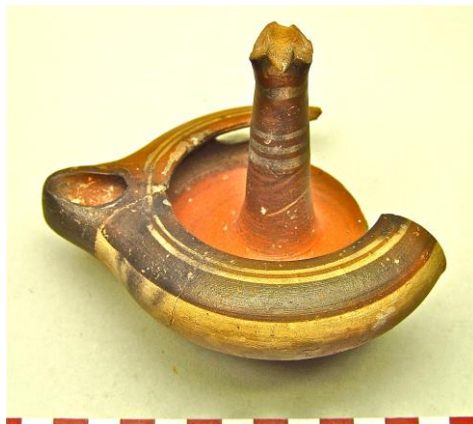

(b) Berezan (OAM) A. 37800



(d) Berezan B. 76-140

Plate 4



(a) Berezan B. 72-199



(c) Histria, Temple area



(b) Berezan B. 64-208

Plate 5



(a) Berezan B. 76-270



(c) Histria, Temple area



(b) Patrasys, passim

Plate 6



B. 64-106



B. 67-163



B. 70-206



B. 69-244



B. 71-253



B. 71-254

Plate 7



B. 73-265



B. 77-208



B. 77-209



B. 78-79

Plate 8



B. 84-203



B. 85-74



B. 89-101

Plate 9



B. 63-155



B. 78-77



B. 84-204



B. 87-38

Plate 10



B. 69-242



B. 72-115



B. 73-185



B. 72-116

Plate 11



B. 74-84



B. 84-91



B. 84-93



B. 89 98



B. 84-96



B. 89-99

Plate 12



B. 63-154



B. 70-204



B. 71-117



B. 71-121



B. 71-256

Plate 13



B. 72-113



B. 72-111



B. 73-202



B. 75-138



B. 76-124

Plate 14



B. 77-210



B. 82-75



B. 89-102



B. 385

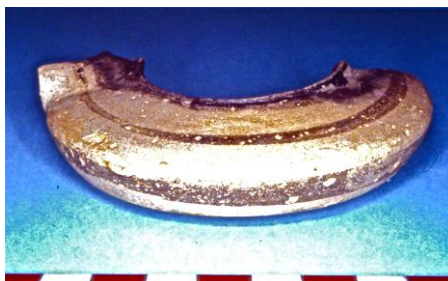

B. 89-100

Plate 15



B. 76-108



B. 82-162



B. 87-99

Plate 16



B. 69-183



B. 77-77

Plate 17



B. 73-320



B. 76-106



B. 86-50



B. 91-79

Plate 18



B. 69-121



B. 73-201



B. 74-96



B. 76-120



B. 84-95



B. 74-232



B. 76-138



B. 77-76



B. 79-57



B. 79-155

Plate 20



B. 62-51



B. 69-237



B. 70-124



B. 73-200



B. 89-103



B. 69-120



B. 75-135



B. 75-139



B. 77-68



B. 82-185



B. 87-37

Plate 22



B. 71-118



B. 72-110



B. 76-140



B. 84-92



B. 84-94



B. 63-152



B. 86-49



B. 63-153



B. 83-185

Plate 24



B. 62-50



B. 69-246



B. 77-211



B. 69-109



B. 71-116



B. 74-85



B. 74-231



B. 76-131

Plate 26



B. 87-100



B. 66-144



Plate 27



B. 67-104



B. 67-110



B. 73-31



B. 77-74



B. 79-58

Plate 28



B. 82-76



B. 87-36



B. 85-146

Plate 29



B. 75-93



B. 65-107

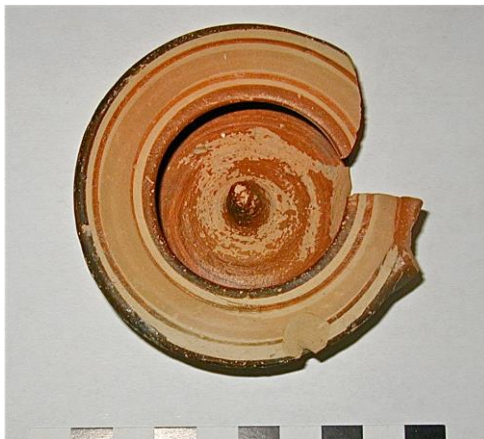

B. 75-95



B. 74-89



B. 91-108



B. 91-167



B. 91-107

Plate 30



B. 64-208



B. 72-199

Plate 31



B. 65-277



B. 89-149



B. 90-102

Plate 32



B. 252



B. 67-159



B.68-104



B. 76-108



B.83-112



B. 85-147



B. 63-326



B.65-375

Plate 34

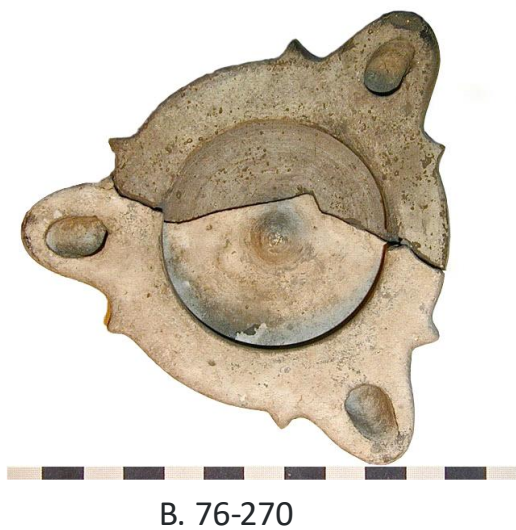

B. 66-158



Plate 35



B. 64-105



B.71-120



B. 73-204



B. 82-158



B. 82-169

Plate 36



B. 82-170



B. 86-51

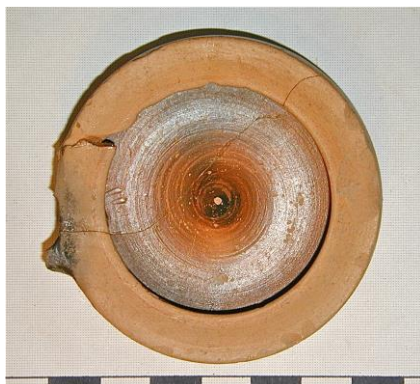

B. 65-118



B. 74-90



B. 82-159



B. 79-74

Plate 37



B. 368



B. 72-112



B. 82-177

Plate 38



B. 63-234



B. 87-106



B. 88-44



La Tour, « Penitent Magdalena »

Plate 39



B. 479



B. 69-235



B. 74-224



Plate 40